



**F.LLI TASSALINI s.p.a.**





**Presentazione**  
**Presentation**  
**Présentation**  
**Presentación**

pagg. 2-6

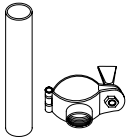

**Tubi - Reggitubi**  
**Pipes - Pipe hangers**  
 **Tubes - Colliers**  
**Tubos - Abrazaderas**

pagg. 7-9

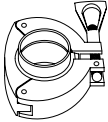

**Raccordi**  
**Unions**  
**Raccords**  
**Racores**

pagg. 10-13

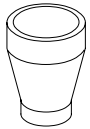

**Riduzioni - Tee - Croci**  
**Reducers - Tees - Crosses**  
**Réductions - Tés - Croix**  
**Reducciones - Tes - Cruces**

pagg. 14-15



**Curve**  
**Bends**  
**Coudes**  
**Codos**

pagg. 16-17

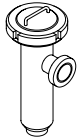

**Filtri - Specole**  
**Filters - Sight glasses**  
**Filters - Regards**  
**Filtros - Mirillas**

pagg. 18-20

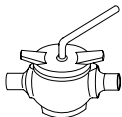

**Rubinetti - Rubinetti di prelievo**  
**Plug cocks - Sampling plugs**  
**Robinets - Robinets dégustateurs**  
**Grifos - Grifos tomamuestras**

pagg. 21-22

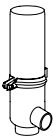

**Valvole di regolazione flusso - Valvole di sicurezza - Valvole di ritegno**  
**Flow control valves - Relief valves - Check valves**  
**Vannes de réglage flux - Soupapes de sûreté - Clapets de retenue**  
**Válvulas de regulación - Válvulas de seguridad - Válvulas de retención**

pagg. 23-25

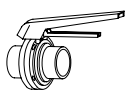

**Valvole a farfalla - Valvole a farfalla a cerniera**  
**Butterfly valves - Hinged butterfly valves**  
**Vannes papillon - Vannes papillon à charnière**  
**Válvulas de mariposa - Válvulas de mariposa de cremallera**

pagg. 26-31

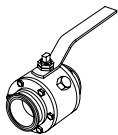

**Valvole a sfera**  
**Ball valves**  
**Vannes à boule**  
**Válvulas de bola**

pagg. 32-35

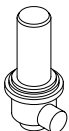

**Valvole pneumatiche norme 3-A**  
**3-A pneumatic valves**  
**Vannes pneumatiques normes 3-A**  
**Válvulas neumáticas normas 3-A**

pagg. 36-43

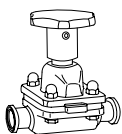

**Valvole a membrana**  
**Diaphragm valves**  
**Vannes à membrane**  
**Válvulas de membrana**

pagg. 44-51

**Norme DIN - Norme ISO**  
**DIN standards - ISO standards**  
**Normes DIN - Normes ISO**  
**Normas DIN - Normas ISO**

pagg. 52-55



La F.LLI TASSALINI OFFICINA MECCANICA S.P.A. opera nel campo delle produzioni meccaniche da oltre 80 anni e da 40 anni costruisce valvole e raccordi tecnologicamente avanzati di sua esclusiva progettazione e fabbricazione per l'industria agroalimentare, enologica, delle bevande, chimica e farmaceutica.

La completa gamma dei prodotti è realizzata in acciaio inossidabile AISI 304L e AISI 316L ed è ricavata da materiale laminato o da particolari stampati a caldo, solubilizzati e lavorati meccanicamente; speciale accuratezza è dedicata alla lavorazione delle parti filettate e l'eliminazione delle parti finali delle filettature è eseguita con operazioni meccaniche a garanzia di assoluta sicurezza durante la manipolazione dei pezzi.

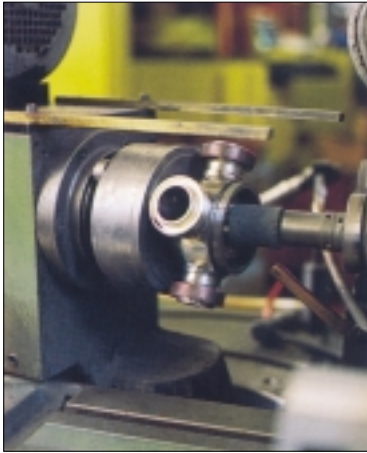

La gamma degli articoli prodotti dalla F.Ili Tassalini s.p.a. è fabbricata secondo le principali norme internazionali (DIN, SMS, RJT BS, ISS IDF, Gas, Eno, Macon e Clamp) e comprende raccordi; riduzioni; tee; curve; filtri e specole; rubinetti; valvole di regolazione, sicurezza e ritegno;

valvole a farfalla di diversi tipi, a comando manuale e pneumatico, predisposti per l'inserimento di componenti elettrici; valvole a sfera; valvole pneumatiche, 3-A e di drenaggio; valvole a membrana.

Tutti i prodotti sono normalmente disponibili a magazzino nelle misure standard e l'ufficio tecnico della F.Ili Tassalini s.p.a. è a disposizione per lo studio di eventuali pezzi speciali necessari alla realizzazione di particolari impianti.

Gli oltre 7000 metri quadrati di superficie nella nuova sede di Peschiera Borromeo hanno garantito una più puntuale organizzazione della produzione, dei controlli e degli stoccaggi a magazzino e hanno consentito l'installazione di una serie di macchine utensili di ultima generazione, di concezione estremamente avanzata e operanti con programmi altamente sofisticati.

Una meticolosa serie di controlli e collaudi rappresenta un ulteriore aspetto operativo che concorre a garantire la qualità dei raccordi e delle valvole F.Ili Tassalini, riconosciuta a livello internazionale.

La F.Ili Tassalini s.p.a. è presente con una rete capillare di propri rivenditori sul mercato europeo e mondiale.

F.LLI TASSALINI OFFICINA MECCANICA S.P.A. has been operating in the machined products industry for over 80 years and for the last 40 years has made high-tech valves and fittings of its own exclusive design and manufacture for the food, wine, beverages, chemical and pharmaceutical industries.

All F.Ili Tassalini s.p.a. products are made of AISI 304L and AISI 316L stainless steel from hot-rolled material or press-forged sections, solution heat-treated and machined. Special care is given to the machining of threaded parts while the elimination of threaded ends is carried out by machining to ensure absolute safety to those handling the parts.

The range of articles produced by F.Ili Tassalini s.p.a. is manufactured in conformity with the main international standards (DIN, SMS, RJT BS, ISS IDF, BSP, Eno, Macon and Clamp standards) and includes unions; reducers; tees; bends; filters and sight glasses; plug cocks; flow control, relief and check valves; different types of butterfly valves with manual or pneumatic controls, designed for the insertion of electrical components; ball valves; pneumatic, 3-A, and drainage valves; diaphragm valves.

All products are stocked in standard dimensions and our engineering department is at the customer's complete disposal to develop customized parts for special systems.

F.Ili Tassalini's new premises in Peschiera Borromeo cover 7000 square metres making it possible to achieve accurate production planning, control and inventory, as well as allowing the installation of a series of latest-generation machine tools, conceived at the most advanced level and operating with highly sophisticated programmes.

A meticulous testing and inspection procedure is an additional aspect of operations which helps ensure the quality of F.Ili Tassalini fittings and valves, recognized worldwide.

F.Ili Tassalini s.p.a. is represented by a complete network of dealers and distributors on European and world markets.





F.LLI TASSALINI OFFICINA MECCANICA S.P.A. opère depuis plus de 80 ans dans le secteur des productions mécaniques et depuis 40 ans l'entreprise fabrique des vannes et des raccords d'un très haut niveau technologique, entièrement conçus et réalisés par elle-même, destinés à l'industrie agro-alimentaire, oenologique, des boissons, chimique et pharmaceutique.

Sa gamme complète de produits est réalisée en acier inoxydable AISI 304L et AISI 316L et est obtenue à partir de matériaux laminés ou de pièces moulées à chaud, solubilisées et usinées mécaniquement. Un soin tout particulier est réservé à l'usinage des parties filetées et l'élimination des extrémités des filetages est réalisée avec des opérations mécaniques garantissant une sécurité absolue pendant le maniement des pièces.

La gamme des articles produits par F.lli Tassalini s.p.a. est fabriquée conformément aux principales normes internationales (DIN, SMS, RJT BS, ISS IDF, Gas, Eno, Macon et Clamp) et se compose de raccords; réductions; tés; coudes; filtres et regards; robinets; vannes de réglage, soupapes de sûreté et clapets de retenue; vannes papillon de différents types, à commande manuelle ou pneumatique, prévus pour l'insertion de composants électriques; vannes à boule; vannes pneumatiques, 3-A et de drainage; vannes à membrane.

Tous les produits sont disponibles en stock dans les mesures standard. Le bureau technique de F.lli Tassalini s.p.a. est en outre disponible pour la conception de pièces spéciales s'avérant nécessaires pour la réalisation d'installations particulières.

Avec une superficie de plus de 7000 m<sup>2</sup>, le nouveau siège de Peschiera Borromeo assure une organisation plus rationnelle de la production, des contrôles et du stockage. Il a également permis d'installer toute une série de machines-outils de la dernière génération, d'une conception d'avant-garde et opérant avec des programmes très sophistiqués.

Une série méticuleuse de contrôles et d'essais représente un autre aspect du travail qui permet de garantir la qualité des raccords et des vannes F.lli Tassalini, une qualité reconnue au niveau international.

La présence de F.lli Tassalini s.p.a. sur les marchés européens et mondiaux est assurée grâce à son réseau très serré de revendeurs.

F.LLI TASSALINI OFFICINA MECCANICA S.P.A. trabaja en el sector de la producción mecánica desde hace más de 80 años y desde hace 40 años construye válvulas y racores tecnológicamente de vanguardia, de su exclusivo diseño y fabricación, para la industria agroalimenticia, enológica, de bebidas, química y farmacéutica.

La gama completa de productos está realizada de acero inoxidable AISI 304L y AISI 316L y se obtiene a partir de material laminado o de piezas estampadas en caliente, solubilizadas y elaboradas mecánicamente; al maquinado de las piezas roscadas se le dedica un esmero especial mientras que la eliminación de las partes terminales de las roscas se efectúa mediante operaciones mecánicas

que garantizan totalmente la seguridad durante la manipulación de las piezas.

La gama de artículos producidos por F.lli Tassalini s.p.a. está fabricada según las principales normas internacionales (DIN, SMS, RJT BS, ISS IDF, Gas, Eno, Macon y Clamp) e incluye racores; reducciones; tes; codos; filtros y mirillas; grifos; válvulas de regulación, de seguridad y de retención; válvulas de mariposa de diferentes tipos, con mando manual o neumático, predispuestos para

conexiones con componentes eléctricos; válvulas de bola; válvulas neumáticas, 3-A y de drenaje; válvulas de membrana.

Normalmente todos los productos se encuentran disponibles en el almacén en las medidas estándar. Para la realización de sistemas especiales el departamento técnico de F.lli Tassalini s.p.a. está a disposición de sus clientes para estudiar las piezas especiales que pudieran ser necesarias.

Los más de 7000 metros cuadrados de superficie en la nueva sede de Peschiera Borromeo garantizan una mejor organización de la producción, de los controles y de las existencias del almacén, y han permitido instalar una serie de máquinas herramientas de última generación, de concepción muy avanzada y que trabajan con programas altamente sofisticados.

Una meticulosa serie de controles y pruebas representa otro de los aspectos operativos que ayudan a garantizar la calidad de los racores y de las válvulas F.lli Tassalini, reconocida en los mercados internacionales.

F.lli Tassalini s.p.a. está presente sobre el mercado europeo y mundial a través de una red muy extendida y ramificada de sus propios revendedores.



|               |               |
|---------------|---------------|
| <b>ACCIAI</b> | <b>STEELS</b> |
| <b>ACIERS</b> | <b>ACEROS</b> |

La completa gamma dei prodotti Clamp è realizzata in acciaio inossidabile AISI 316L.

All Clamp products are made of AISI 316L stainless steel.

La gamme complète des produits Clamp est réalisée en acier inoxydable AISI 316L.

La gama completa de productos Clamp está realizada en acero inoxidable AISI 316L.

|  |                                  |   |   |  |  |
|--|----------------------------------|---|---|--|--|
| Italia<br>Italy<br>Italie<br>Italia<br>UNI | USA<br>USA<br>USA<br>USA<br>AISI | Germania<br>Germany<br>Allemagne<br>Alemania<br>WERKSTOFF | Francia<br>France<br>France<br>Francia<br>AFNOR | Svezia<br>Sweden<br>Suède<br>Suecia<br>SIS | Gran Bretagna<br>Great Britain<br>Grande-Bretagne<br>Gran Bretaña<br>BSI |
| X2CrNiMo17-12                              | 316L                             | 1.4404  | Z2CND 17-12                                     | 2348                                       | 316S11   |

COMPOSIZIONE CHIMICA  
CHEMICAL COMPOSITION  
COMPOSITION CHIMIQUE  
COMPOSICIÓN QUÍMICA

|    |   |       |
|----|---|-------|
| C  | ≤ | 0,03  |
| Cr | ≥ | 17,00 |
| Ni | ≥ | 12,00 |
| Mo | ≥ | 2,25  |
| Si | ≤ | 0,30  |
| Mn | ≤ | 1,40  |
| S  | ≤ | 0,02  |
| P  | ≤ | 0,02  |

CARATTERISTICHE MECCANICHE  
MECHANICAL CHARACTERISTICS  
CARACTÉRISTIQUES MÉCANIQUES  
CARACTERÍSTICAS MECÁNICAS

|     |    |   |     |
|-----|----|---|-----|
| Hd  | 18 | ÷ | 220 |
| R   | 65 | ÷ | 75  |
| S   | ≥  |   | 23  |
| AP5 | ≥  |   | 50  |
| C   | ≥  |   | 60  |
| KI  | ≥  |   | 18  |

|                   |                 |
|-------------------|-----------------|
| <b>FINITURE</b>   | <b>FINISHES</b> |
| <b>FINISSAGES</b> | <b>ACABADOS</b> |

| GRIT | Max R <sub>a</sub> μm | Max r <sub>a</sub> μ" |
|------|-----------------------|-----------------------|
| 150  | 0,76-0,89             | 30-35                 |
| 240  | 0,38-0,51             | 15-20                 |
| 400  | ≤0,2                  | ≤8                    |

- 150 GRIT
  - Finitura LS: lucidatura esterna e satinatura interna.
  - LS finish: external polishing and internal glazing.
  - Finissage LS: polissage extérieur et satinage intérieur.
  - Acabado LS: pulido exterior y satinado interior.
- 240 GRIT
  - Finitura LL: lucidatura esterna e interna.
  - LL finish: external and internal polishing.
  - Finissage LL: polissage extérieur et intérieur.
  - Acabado LL: pulido exterior e interior.
- 400 GRIT
  - Finitura LE: lucidatura elettrolitica.
  - LE finish: electrolytic polishing.
  - Finissage LE: polissage électrolytique.
  - Acabado LE: pulido electrolítico.



### 3-A SANITARY STANDARDS AUTHORIZATIONS NO. 538, 645, 787, 1199, 1200

Tutti i raccordi Clamp, i rubinetti, le valvole a sfera modello 90, le valvole pneumatiche e le valvole a membrana sono realizzati seguendo rigorosamente i criteri e i test imposti dalle norme 3-A.

All Clamps fittings, plug cocks, ball valves model 90, pneumatic valves and diaphragm valves are produced in strict conformity with criteria and tests required by 3-A standards.

Tous les raccords Clamp, les robinets, les vannes à boule modèle 90, les vannes pneumatiques et les vannes à membrane sont réalisés en respectant scrupuleusement les critères et les tests imposés par les normes 3-A.

Todos los racores Clamp, los grifos, las válvulas de bola modelo 90, las válvulas neumáticas y las válvulas de membrana son realizados respetando rigurosamente los criterios y los tests establecidos por las normas 3-A.



## PRODOTTI CLAMP

- **Elevato grado di igienicità**  
Le superfici interne perfettamente lisce e prive di zone di ritenzione assicurano il flusso continuo del prodotto, minimizzando le perdite di carico e il pericolo di contaminazione.
- **Accoppiamenti e allineamenti di precisione**  
La perfetta circolarità alle estremità e in ogni sezione trasversale consente accoppiamenti e allineamenti di precisione.
- **Facilità di installazione**  
Le rigide tolleranze dimensionali assicurano un veloce assemblaggio e costi di installazione ridotti.
- **Facilità di manutenzione**  
Manutenzioni ridotte con facilità di accesso.
- **Elevata resistenza alla corrosione**  
La solubilizzazione dei prodotti ne assicura l'elevata resistenza alla corrosione e la lunga durata di esercizio.
- **Atossicità degli elastomeri**  
Ampia gamma di elastomeri non tossici, non assorbenti e resistenti agli agenti di contatto.

## PRODUITS CLAMP

- **Niveau d'hygiène élevé**  
Les surfaces internes parfaitement lisses et sans zones de rétention garantissent le flux continu du produit tout en réduisant au minimum les pertes de charge et le risque de contamination.
- **Accouplements et alignements de précision**  
La circularité parfaite aux extrémités et dans chaque section transversale permet des accouplements et des alignements de la plus grande précision.
- **Facilité d'installation**  
Les tolérances dimensionnelles sévères adoptées assurent une grande rapidité d'assemblage et des coûts d'installation réduits.
- **Facilité d'entretien**  
Opérations d'entretien réduites au minimum et accès facile.
- **Résistance élevée à la corrosion**  
La solubilisation des produits offre une résistance élevée à la corrosion et leur procure une longue durée de vie.
- **Atoxicité des élastomères**  
Vaste gamme d'élastomères non-toxiques, non-absorbants et résistant aux agents de contact.

## CLAMP PRODUCTS

- **High hygiene level**  
Perfectly smooth internal surfaces free from retention areas ensure continuous product flow, minimal pressure drop and minimal danger of contamination.
- **Accurate coupling and alignment**  
Perfect roundness at ends and all cross sections allows accurate coupling and alignment.
- **Ease of installation**  
Strict dimensional tolerances ensure fast assembly and low installation costs.
- **Ease of maintenance**  
Low maintenance with ease of access.
- **High corrosion resistance**  
Solubilization of products ensures high corrosion resistance and long working life.
- **Non-toxicity of elastomers**  
Broad range of non-toxic, non-absorbent agent-resistant elastomers.

## PRODUCTOS CLAMP

- **Elevado grado de higiene**  
Las superficies internas perfectamente lisas y sin zonas de retención aseguran el flujo continuo del producto minimizando las pérdidas de carga y el peligro de contaminación.
- **Acoplamiento y alineamiento de precisión**  
La perfecta forma circular de los extremos y de cada sección transversal permite realizar acoplamiento y alineamiento de precisión.
- **Facilidad de instalación**  
Las rígidas tolerancias dimensionales aseguran un rápido ensamblado y costos de instalación reducidos.
- **Facilidad de mantenimiento**  
Mantenimiento reducido con facilidad de acceso.
- **Elevada resistencia a la corrosión**  
La solubilización de los productos asegura una elevada resistencia a la corrosión y una larga duración de ejercicio.
- **No toxicidad de los elastómeros**  
Amplia gama de elastómeros no tóxicos, no absorbentes y resistentes a los agentes de contacto.





## TUBI

- Fabbricati in acciaio inossidabile AISI 316L; ricavati da nastri ricotti con finitura BA o 2B, saldati in argon con sistema TIG, calibrati, con cordone di saldatura interno laminato a freddo e scordonati esternamente mediante tele abrasive. Solubilizzati in atmosfera controllata.
- Sottoposti a controlli non distruttivi (linea di controllo a correnti parassite), verifica delle caratteristiche meccaniche, controllo dimensionale ed esame delle superfici.
- Prodotti in accordo con le tolleranze dimensionali prescritte dalle norme di fabbricazione ASTM A269 e A270.

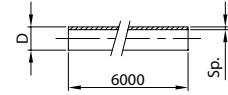

| DN     | D     | Sp.  | gr    |
|--------|-------|------|-------|
| 1/2"   | 12,7  | 1,65 | 400   |
| 3/4"   | 19,0  | 1,65 | 719   |
| 1"     | 25,4  | 1,25 | 756   |
| 1"     | 25,4  | 1,65 | 981   |
| 1 1/2" | 38,1  | 1,25 | 1.154 |
| 1 1/2" | 38,1  | 1,65 | 1.506 |
| 2"     | 50,8  | 1,25 | 1.551 |
| 2"     | 50,8  | 1,65 | 2.031 |
| 2 1/2" | 63,5  | 1,65 | 2.556 |
| 3"     | 76,1  | 1,65 | 3.076 |
| 4"     | 101,6 | 2,11 | 5.256 |
| 4"     | 104,0 | 2    | 5.108 |

## PIPES

- Manufactured from AISI 316L stainless steel. Made from annealed sheet with BA or 2B finish, argon welded with the TIG system, gauged, with cold-rolled internal weld bead and deburred externally with emery cloth. Solution heat-treated in controlled atmosphere.
- Subjected to non-destructive inspection (inspection line with parasite currents), check on mechanical features, dimensional inspection and surface examination.
- Produced in conformity with dimensional tolerance levels stipulated in ASTM A269 and A270 manufacturing standards.

## TUBES

- Fabriqués en acier inoxydable AISI 316L. Obtenus à partir de feuillards recuits avec finissage BA ou 2B, soudés à l'argon avec le système TIG, calibrés, avec bourrelet de soudure intérieur laminé à froid et débourelés à l'extérieur avec de la toile abrasive. Solubilisés en atmosphère contrôlée.
- Soumis à des contrôles non destructifs (ligne de contrôle à courants parasites), vérification des caractéristiques mécaniques, contrôle des dimensions et examen des surfaces.
- Produits conformes aux tolérances dimensionnelles prescrites par les normes de fabrication ASTM A269 et A270.

## TUBOS

- Fabricados en acero inoxidable AISI 316L; obtenidos a partir de planchas recocidas con acabado BA o 2B, soldados en argón mediante el sistema TIG, calibrados, con cordón de soldadura interior laminado en frío y sin cordón exterior mediante telas abrasivas. Solubilizados en atmósfera controlada.
- Sometidos a controles no destructivos (línea de control de corrientes parásitas), verificación de las características mecánicas, control de las dimensiones y examen de las superficies.
- Producidos de acuerdo a las tolerancias de dimensiones prescritas por las normas de fabricación ASTM A269 y A270.







## REGGITUBI

- Fabricati in acciaio inossidabile AISI 304L con superficie elettrolucidata.
- Di solida costruzione, garantiscono un sostegno sicuro ed efficace.
- 092 • Supporto inferiore e supporto superiore uguali. Supporto inferiore corredabile di un tronchetto saldato. Collegamento tra supporto inferiore e supporto superiore mediante galletto o dado esagonale.
- 094 • Reggitubo di forma ottagonale completo di segmenti plastici per eliminare l'attrito durante la dilatazione delle tubazioni e garantire il totale isolamento dielettrico. Supporto inferiore collegato ad articolazione con il supporto superiore mediante una cerniera. Filettatura 1/2" Gas nella parte terminale del reggitubo 094 F per permettere l'eventuale inserimento di un tronchetto filettato disponibile in differenti lunghezze.

## PIPE HANGERS

- Made of AISI 304L stainless steel with electropolished surface.
- High strength construction to ensure safe effective support.
- 092 • The same lower and upper supports. Lower support may be fitted with welded pipe. Connection between lower and upper support with wing nuts or hexagonal nuts.
- 094 • Octagonal pipe hanger equipped with plastic segments designed to eliminate friction during expansion of piping and ensure complete dielectric insulation. Lower support hinged to upper support. 1/2" BSP thread in the terminal part of the pipe hanger 094 F to allow insertion of a threaded pipe available in different lengths.

## COLLIERS

- Fabriqués en acier inoxydable AISI 304L, avec surface électroplie.
- D'une construction robuste, ils garantissent un soutien sûr et efficace.
- 092 • Support inférieur et support supérieur identiques. Possibilité d'installer un fourreau soudé sur le support inférieur. Attelage du support inférieur et du support supérieur à l'aide de vis à oreilles ou de écrou 6 pans.
- 094 • Collier de forme octogonale muni de segments en plastique capables d'éliminer le frottement durant la dilatation des tubes et de garantir une isolation diélectrique totale. Support inférieur articulé et raccordé au support supérieur par une charnière. Filetage 1/2" Gas dans la partie finale du collier 094 F pour permettre l'éventuelle insertion d'un fourreau fileté disponible en différentes longueurs.

## ABRAZADERAS

- Fabricadas de acero inoxidable AISI 304L con superficie pulida eléctricamente.
- De sólida construcción, garantizan un sostén seguro y eficaz.
- 092 • Soporte inferior y soporte superior iguales. El soporte inferior se puede entregar junto con un espárrago soldado. Conexión entre el soporte inferior y el soporte superior a través de una tuerca mariposa o bien una tuerca hexagonal.
- 094 • Abrazadera de forma octagonal completa de segmentos plásticos que permiten eliminar el rozamiento durante la dilatación de los tubos y garantizan el total aislamiento dieléctrico. Soporte inferior articulado al soporte superior mediante una cremallera. Rosca 1/2" Gas en la parte terminal de la abrazadera 094 F para permitir la posible introducción de un espárrago disponible en diferentes longitudes.





REGGITUBO EL.  
PIPE HANGER PE.  
COLLIER BL.  
ABRAZADERA EL.

**092 LD**

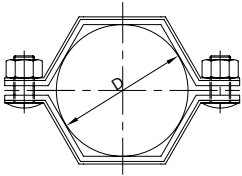

| DN        | D     | gr  |
|-----------|-------|-----|
| 1" 25     | 25,4  | 110 |
| 1 1/2" 38 | 38,1  | 130 |
| 2" 51     | 50,8  | 160 |
| 2 1/2" 63 | 63,5  | 200 |
| 3" 76     | 76,1  | 220 |
| 4" 101    | 101,6 | 270 |

REGGITUBO EL.  
PIPE HANGER PE.  
COLLIER BL.  
ABRAZADERA EL.

**092 LG**

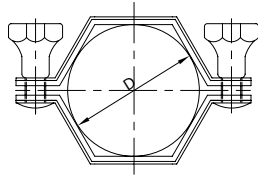

| DN        | D     | gr  |
|-----------|-------|-----|
| 1" 25     | 25,4  | 110 |
| 1 1/2" 38 | 38,1  | 130 |
| 2" 51     | 50,8  | 160 |
| 2 1/2" 63 | 63,5  | 200 |
| 3" 76     | 76,1  | 220 |
| 4" 101    | 101,6 | 270 |

REGG. TRONCHETTO  
STUB PIPE HANGER  
COLLIER FOURREAU  
ABR. ESPARRAGO

**092 TD**

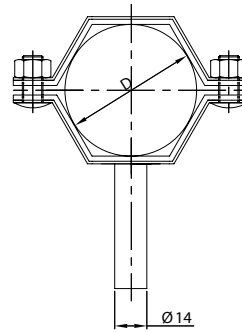

| DN        | D     | gr  |
|-----------|-------|-----|
| 1" 25     | 25,4  | 110 |
| 1 1/2" 38 | 38,1  | 130 |
| 2" 51     | 50,8  | 160 |
| 2 1/2" 63 | 63,5  | 200 |
| 3" 76     | 76,1  | 220 |
| 4" 101    | 101,6 | 270 |

REGG. TRONCHETTO  
STUB PIPE HANGER  
COLLIER FOURREAU  
ABR. ESPARRAGO

**092 TG**

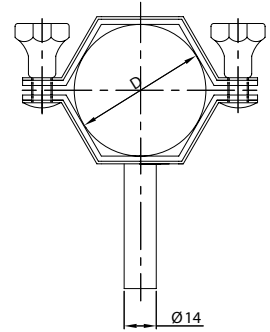

| DN        | D     | gr  |
|-----------|-------|-----|
| 1" 25     | 25,4  | 110 |
| 1 1/2" 38 | 38,1  | 130 |
| 2" 51     | 50,8  | 160 |
| 2 1/2" 63 | 63,5  | 200 |
| 3" 76     | 76,1  | 220 |
| 4" 101    | 101,6 | 270 |

REGGIT. OTTAGONALE EL.  
OCTAGONAL P. HANGER PE.  
COLLIER OCTOGONAL BL.  
ABRAZAD. OCTAGONAL EL.

**094 L**

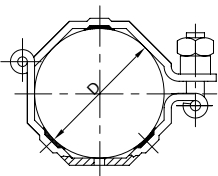

| DN        | D     | gr  |
|-----------|-------|-----|
| 1" 25     | 25,4  | 110 |
| 1 1/2" 38 | 38,1  | 130 |
| 2" 51     | 50,8  | 160 |
| 2 1/2" 63 | 63,5  | 200 |
| 3" 76     | 76,1  | 220 |
| 4" 101    | 101,6 | 270 |

REGGIT. OTTAGONALE EF.  
OCTAGONAL P. HANGER ME.  
COLLIER OCTOGONAL BF.  
ABRAZAD. OCTAGONAL ER.

**094 F**

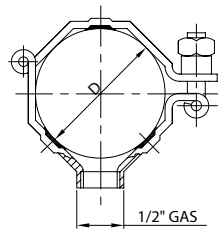

| DN        | D     | gr  |
|-----------|-------|-----|
| 1" 25     | 25,4  | 110 |
| 1 1/2" 38 | 38,1  | 130 |
| 2" 51     | 50,8  | 160 |
| 2 1/2" 63 | 63,5  | 200 |
| 3" 76     | 76,1  | 220 |
| 4" 101    | 101,6 | 270 |

R. OTT. TRONCHETTO  
STUB OCT. PIPE HANGER  
COLLIER OCT. FOURREAU  
ABR. OCT. ESPARRAGO

**094 T**

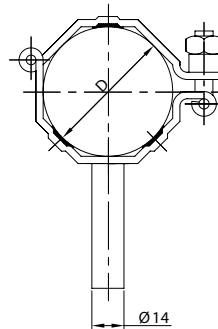

| DN        | D     | gr  |
|-----------|-------|-----|
| 1" 25     | 25,4  | 130 |
| 1 1/2" 38 | 38,1  | 150 |
| 2" 51     | 50,8  | 180 |
| 2 1/2" 63 | 63,5  | 220 |
| 3" 76     | 76,1  | 240 |
| 4" 101    | 101,6 | 290 |

TRONCHETTO FILETTATO  
THREADED PIPE  
FOURREAU FILETÉ  
ESPARRAGO

**095 G**

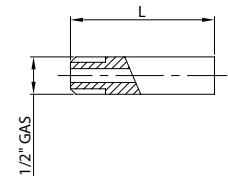

| Cod.      | G    | L     |
|-----------|------|-------|
| 095 G 50  | 1/2" | 50,0  |
| 095 G 100 | 1/2" | 100,0 |
| 095 G 150 | 1/2" | 150,0 |
| 095 G 200 | 1/2" | 200,0 |

## RACCORDI

- Ricavati da particolari stampati a caldo o laminati e solubilizzati.
- Chiusura rapida conformemente alle norme 3-A.
- Produzione standard: 1/2" – 4"; a richiesta, dimensioni fino a 8".
- A richiesta, produzione a norme DIN e ISO.
- Certificazioni di materiale e test di rugosità disponibili su richiesta.

## UNIONS

- Made from hot-rolled or press-forged material and solution heat-treated.
- Quick closing in conformity with 3-A standards.
- Standard production: 1/2" – 4". Up to 8" on request.
- On request, production in conformity with DIN and ISO standards.
- Material certification and roughness tests available on request.



**MORSETTO DOPPIO  
HEAVY DUTY CLAMP  
COLLIER CLAMP  
ABRAZADERA**

**K12**

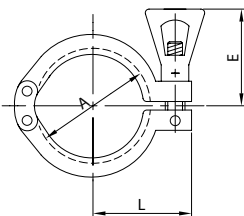

| DN        | A     | E    | L    | gr  |
|-----------|-------|------|------|-----|
| 1/2" 12   | 27,0  | 35,0 | 27,0 | 120 |
| 3/4" 19   | 27,0  | 35,0 | 27,0 | 120 |
| 1" 25     | 53,4  | 53,0 | 43,0 | 220 |
| 1 1/2" 38 | 53,4  | 53,0 | 43,0 | 220 |
| 2" 51     | 67,0  | 53,0 | 50,0 | 260 |
| 2 1/2" 63 | 80,4  | 53,0 | 56,5 | 330 |
| 3" 76     | 94,0  | 53,0 | 65,0 | 400 |
| 4" 101    | 122,0 | 53,0 | 85,0 | 500 |

**MORSETTO 3 GANASCE  
HEAVY DUTY CL. 3 PIECES  
COLLIER CLAMP 3 PIÈCES  
ABRAZAD. 3 MORDAZAS**

**K13**

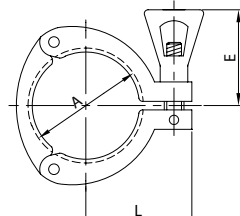

| DN        | A     | E    | L    | gr  |
|-----------|-------|------|------|-----|
| 1" 25     | 53,4  | 53,0 | 45,0 | 270 |
| 1 1/2" 38 | 53,4  | 53,0 | 45,0 | 270 |
| 2" 51     | 67,0  | 53,0 | 51,5 | 330 |
| 2 1/2" 63 | 80,4  | 53,0 | 58,2 | 395 |
| 3" 76     | 94,0  | 53,0 | 65,0 | 425 |
| 4" 101    | 122,0 | 53,0 | 81,0 | 540 |

**MORSETTO DOPPIO  
HEAVY DUTY CLAMP  
COLLIER CLAMP  
ABRAZADERA**

**K15**

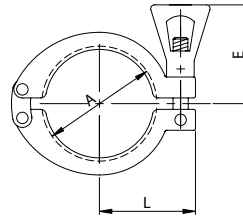

| DN        | A     | E    | L    | gr  |
|-----------|-------|------|------|-----|
| 1/2" 25   | 54,5  | 53,0 | 43,7 | 220 |
| 1 1/2" 38 | 54,5  | 53,0 | 43,7 | 220 |
| 2" 51     | 68,0  | 53,0 | 50,5 | 260 |
| 2 1/2" 63 | 81,5  | 53,0 | 57,2 | 330 |
| 3" 76     | 95,0  | 53,0 | 64,0 | 400 |
| 4" 101    | 123,0 | 53,0 | 78,0 | 500 |

**MORSETTO DOPPIO  
HEAVY DUTY CLAMP  
COLLIER CLAMP  
ABRAZADERA**

**K12 HP**

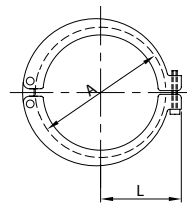

| DN     | A     | L     | gr    |
|--------|-------|-------|-------|
| 5" 127 | 148,0 | 95,0  | 750   |
| 6" 152 | 170,0 | 111,0 | 1.450 |
| 8" 203 | 222,0 | 137,0 | 1.750 |





## RACCORDS

- Obtenus à partir de pièces moulées à chaud ou laminées et solubilisées.
- Fermeture rapide conforme aux normes 3-A.
- Production standard: 1/2" – 4"; sur demande, dimensions jusqu'à 8".
- Sur demande, production conforme aux normes DIN et ISO.
- Certifications des matériaux et tests de rugosité disponibles sur demande.

**SEMIRACC. CORTO SR.  
SHORT WG. FERRULE  
FERRULE SR. COURTE  
ENLACE CORTO SR.**

### K14 S

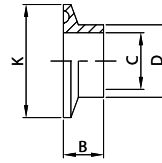

| DN     | B   | C    | D     | K     | gr        |
|--------|-----|------|-------|-------|-----------|
| 1/2"   | 12  | 12,7 | 9,4   | 12,7  | 25,0 16   |
| 3/4"   | 19  | 12,7 | 15,7  | 19,0  | 25,0 14   |
| 1"     | 25  | 12,7 | 22,1  | 25,4  | 50,5 60   |
| 1 1/2" | 38  | 12,7 | 34,8  | 38,1  | 50,5 40   |
| 2"     | 51  | 12,7 | 47,5  | 50,8  | 64,0 60   |
| 2 1/2" | 63  | 12,7 | 60,2  | 63,5  | 77,5 75   |
| 3"     | 76  | 12,7 | 72,9  | 76,2  | 91,0 95   |
| 4"     | 101 | 15,8 | 97,4  | 101,6 | 119,0 180 |
| 4"     | 104 | 15,8 | 100,0 | 104,0 | 119,0 180 |

**SEMIRACCORDO SR.  
WG. FERRULE  
FERRULE SR.  
ENLACE SR.**

### K14 W

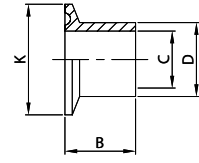

| DN     | B   | C    | D     | K     | gr        |
|--------|-----|------|-------|-------|-----------|
| 1/2"   | 12  | 21,0 | 9,4   | 12,7  | 25,0 19   |
| 3/4"   | 19  | 21,0 | 15,7  | 19,0  | 25,0 20   |
| 1"     | 25  | 28,6 | 22,1  | 25,4  | 50,5 80   |
| 1 1/2" | 38  | 28,6 | 34,8  | 38,1  | 50,5 60   |
| 2"     | 51  | 28,6 | 47,5  | 50,8  | 64,0 95   |
| 2 1/2" | 63  | 28,6 | 60,2  | 63,5  | 77,5 115  |
| 3"     | 76  | 28,6 | 72,9  | 76,2  | 91,0 150  |
| 4"     | 101 | 28,6 | 97,4  | 101,6 | 119,0 250 |
| 4"     | 104 | 28,6 | 100,0 | 104,0 | 119,0 250 |
| 5"     | 127 | 28,6 | 122,0 | 127,0 | 144,4 320 |
| 6"     | 152 | 28,6 | 147,4 | 152,4 | 166,0 400 |
| 8"     | 203 | 28,6 | 198,2 | 203,2 | 217,0 500 |



**SEMIRACC. LUNGO SR.  
LONG WG. FERRULE  
FERRULE SR. LONGUE  
ENLACE LARGO SR.**

### K14 WL

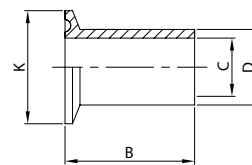

| DN     | B   | C     | D     | K     | gr        |
|--------|-----|-------|-------|-------|-----------|
| 1"     | 25  | 76,2  | 22,1  | 25,4  | 50,5 120  |
| 1 1/2" | 38  | 76,2  | 34,8  | 38,1  | 50,5 130  |
| 2"     | 51  | 76,2  | 47,5  | 50,8  | 64,0 180  |
| 2 1/2" | 63  | 76,2  | 60,2  | 63,5  | 77,5 280  |
| 3"     | 76  | 101,6 | 72,9  | 76,2  | 91,0 380  |
| 4"     | 101 | 101,6 | 97,4  | 101,6 | 119,0 560 |
| 4"     | 104 | 101,6 | 100,0 | 104,0 | 119,0 560 |

**SEMIRACCORDO MR.  
ROLL-ON FERRULE  
FERRULE DR.  
ENLACE MR.**

### K14 R

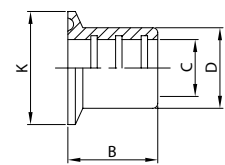

| DN     | B   | C    | D     | K     | gr        |
|--------|-----|------|-------|-------|-----------|
| 1"     | 25  | 19,0 | 25,4  | 29,6  | 50,5 60   |
| 1 1/2" | 38  | 28,6 | 38,1  | 42,6  | 50,5 65   |
| 2"     | 51  | 33,4 | 50,8  | 55,8  | 64,0 105  |
| 2 1/2" | 63  | 35,0 | 63,5  | 68,8  | 77,5 145  |
| 3"     | 76  | 36,5 | 76,2  | 82,0  | 91,0 190  |
| 4"     | 101 | 38,0 | 101,6 | 110,0 | 119,0 300 |

## RACORES

- Obtenidos a partir de piezas estampadas en caliente o laminadas y solubilizadas.
- Cierre rápido en conformidad con las normas 3-A.
- Producción estándar: 1/2" – 4"; a pedido, dimensiones de hasta 8".
- A pedido, producción según normas DIN e ISO.
- Certificaciones de materiales y tests de rugosidad disponibles a pedido.



PORTAGOMMA E. SM.  
HOSE ADAPTOR E. FR.  
PORTE CAOUTCHOUC B. FR.  
M. MANGUERA E. SM.

### K14 RHA

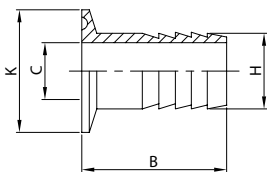

| DN        | B    | C    | H     | K     | gr  |
|-----------|------|------|-------|-------|-----|
| 1/2" 12   | 38,1 | 9,5  | 12,7  | 25,0  | 26  |
| 3/4" 19   | 38,1 | 15,7 | 19,0  | 25,0  | 40  |
| 1" 25     | 42,9 | 20,6 | 25,4  | 50,5  | 70  |
| 1 1/2" 38 | 42,9 | 33,3 | 38,1  | 50,5  | 140 |
| 2" 51     | 58,7 | 46,0 | 50,8  | 64,0  | 250 |
| 2 1/2" 63 | 59,5 | 58,7 | 63,5  | 77,5  | 370 |
| 3" 76     | 78,6 | 72,0 | 76,2  | 91,0  | 505 |
| 4" 101    | 86,5 | 97,4 | 101,6 | 119,0 | 685 |

SEMIRACCORDO EF. GAS  
BSP ADAPTOR  
FERRULE BF. GAS  
ENLACE ROSCA GAS

### K14 BSPM

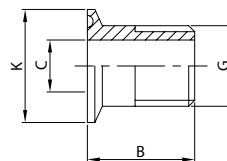

| DN        | B    | C    | G      | K     | gr  |
|-----------|------|------|--------|-------|-----|
| 1" 25     | 30,0 | 21,7 | 1"     | 50,5  | 70  |
| 1 1/2" 38 | 32,0 | 34,4 | 1 1/2" | 50,5  | 140 |
| 2" 51     | 36,0 | 47,1 | 2"     | 64,0  | 250 |
| 2 1/2" 63 | 39,0 | 59,8 | 2 1/2" | 77,5  | 370 |
| 3" 76     | 46,0 | 72,5 | 3"     | 91,0  | 505 |
| 4" 101    | 56,0 | 96,7 | 4"     | 119,0 | 685 |

TAPPO  
SOLID END CAP  
BOUCHON  
TAPÓN

### K16

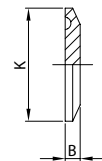

| DN        | B    | K     | gr    |
|-----------|------|-------|-------|
| 1/2" 12   | 4,7  | 25,0  | 16    |
| 3/4" 19   | 4,7  | 25,0  | 16    |
| 1" 25     | 6,4  | 50,5  | 70    |
| 1 1/2" 38 | 6,4  | 50,5  | 70    |
| 2" 51     | 6,4  | 64,0  | 140   |
| 2 1/2" 63 | 6,4  | 77,5  | 200   |
| 3" 76     | 6,4  | 91,0  | 410   |
| 4" 101    | 7,9  | 119,0 | 570   |
| 5" 127    | 11,0 | 144,4 | 1.400 |
| 6" 152    | 13,0 | 166,0 | 2.200 |
| 8" 203    | 13,0 | 217,0 | 3.700 |

## GUARNIZIONI

- Fornite in tre differenti modelli: guarnizione Clamp standard, guarnizione a labbro, guarnizione a busta.

## GASKETS

- Supplied in three different models: standard Clamp gasket, lip gasket, envelope gasket.

## JOINTS

- Fournis en trois différents modèles: joint Clamp standard, joint à lèvres, joint à enveloppe.

## JUNTAS

- Se suministran en tres modelos diferentes: junta Clamp estándar, junta de reborde, junta de sobre.

- K40
  - EPDM
  - Silicone
  - PTFE
  - FTM
- K39
  - EPDM
  - PTFE
  - Silicone e FTM a richiesta / Silicone or FTM on request / Silicone et FTM sur demande / Silicone y FTM a pedido
- K40 TE
  - EPDM rivestito PTFE / PTFE-coated EPDM / EPDM revêtu PTFE / EPDM revestido PTFE



### GUARNIZIONE GASKET JOINT JUNTA

#### K40

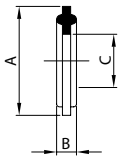

| DN     | A   | B     | C   |
|--------|-----|-------|-----|
| 1/2"   | 12  | 21,8  | 4,5 |
| 3/4"   | 19  | 21,8  | 4,5 |
| 1"     | 25  | 49,5  | 5,3 |
| 1 1/2" | 38  | 49,5  | 5,3 |
| 2"     | 51  | 63,0  | 5,3 |
| 2 1/2" | 63  | 76,5  | 5,3 |
| 3"     | 76  | 90,0  | 5,3 |
| 4"     | 101 | 118,0 | 5,3 |
| 5"     | 127 | 143,4 | 5,3 |
| 6"     | 152 | 165,0 | 5,3 |
| 8"     | 203 | 216,0 | 5,3 |

### GUARNIZIONE A LABBRO LIP GASKET JOINT À LÈVRE JUNTA DE REBORDE

#### K39

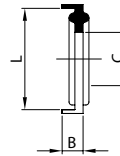

| DN     | B   | C   | L    |
|--------|-----|-----|------|
| 1/2"   | 12  | 4,5 | 10,0 |
| 3/4"   | 19  | 4,5 | 16,5 |
| 1"     | 25  | 5,3 | 23,2 |
| 1 1/2" | 38  | 5,3 | 36,2 |
| 2"     | 51  | 5,3 | 49,2 |
| 2 1/2" | 63  | 5,3 | 60,5 |
| 3"     | 76  | 5,3 | 73,1 |
| 4"     | 101 | 5,3 | 97,6 |

### GUARNIZIONE A BUSTA ENVELOPE GASKET JOINT À ENVELOPPE JUNTA DE SOBRE

#### K40 TE

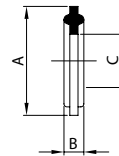

| DN     | A   | B     | C   |
|--------|-----|-------|-----|
| 1/2"   | 12  | 21,8  | 4,5 |
| 3/4"   | 19  | 21,8  | 4,5 |
| 1"     | 25  | 49,5  | 5,3 |
| 1 1/2" | 38  | 49,5  | 5,3 |
| 2"     | 51  | 63,0  | 5,3 |
| 2 1/2" | 63  | 76,5  | 5,3 |
| 3"     | 76  | 90,0  | 5,3 |
| 4"     | 101 | 118,0 | 5,3 |
| 5"     | 127 | 143,4 | 5,3 |
| 6"     | 152 | 165,0 | 5,3 |
| 8"     | 203 | 216,0 | 5,3 |





## RIDUZIONI – TEE – CROCI

- Ricavati da tubi elettrouniti laminati a freddo e solubilizzati.
- Calibrati internamente ed esternamente al fine di ottenere una buona circolarità.
- Intestati alle estremità per assicurare la perfetta ortogonalità dei piani.
- Produzione standard: 1/2" – 4"; a richiesta, dimensioni fino a 8".
- A richiesta, produzione a norme DIN e ISO.
- Certificazioni di materiale e test di rugosità disponibili su richiesta.

RIDUZIONE CONC. EL.  
 CONC. REDUCER PE.  
 RÉDUCTION CONC. BL.  
 REDUCCIÓN CONC. EL.

### W31

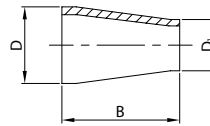

| DN          | B      | D    | D <sub>1</sub> | gr       |
|-------------|--------|------|----------------|----------|
| 3/4"-1/2"   | 19/12  | 25,4 | 19,0           | 12,7 50  |
| 1"-1/2"     | 25/12  | 25,4 | 25,4           | 12,7 70  |
| 1"-3/4"     | 25/19  | 25,4 | 25,4           | 19,0 80  |
| 1 1/2"-1/2" | 38/12  | 50,8 | 38,1           | 12,7 90  |
| 1 1/2"-3/4" | 38/19  | 50,8 | 38,1           | 19,0 90  |
| 1 1/2"-1"   | 38/25  | 67,0 | 38,1           | 25,4 100 |
| 2"-1 1/2"   | 51/38  | 67,0 | 50,8           | 38,1 140 |
| 2 1/2"-2"   | 63/51  | 67,0 | 63,5           | 50,8 160 |
| 3"-2"       | 76/51  | 67,0 | 76,2           | 50,8 180 |
| 3"-2 1/2"   | 76/63  | 67,0 | 76,2           | 63,5 220 |
| 4"-3"       | 101/76 | 67,0 | 101,6          | 76,2 280 |

RIDUZIONE CONC. E. SM.  
 CONC. REDUCER E. FR.  
 RÉDUCTION CONC. B. FR.  
 REDUCCIÓN CONC. E. SM.

### K31

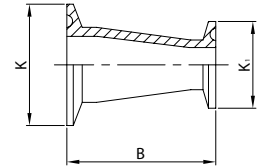

| DN          | B      | K    | K <sub>1</sub> | gr       |
|-------------|--------|------|----------------|----------|
| 3/4"-1/2"   | 19/12  | 50,8 | 25,0           | 25,0 80  |
| 1"-1/2"     | 25/12  | 50,8 | 50,5           | 25,0 140 |
| 1"-3/4"     | 25/19  | 50,8 | 50,5           | 25,0 160 |
| 1 1/2"-1/2" | 38/12  | 76,2 | 50,5           | 25,0 200 |
| 1 1/2"-3/4" | 38/19  | 76,2 | 50,5           | 25,0 200 |
| 1 1/2"-1"   | 38/25  | 92,4 | 50,5           | 50,5 240 |
| 2"-1 1/2"   | 51/38  | 92,4 | 64,0           | 50,5 250 |
| 2 1/2"-2"   | 63/51  | 92,4 | 77,5           | 64,0 300 |
| 3"-2"       | 76/51  | 92,4 | 91,0           | 64,0 400 |
| 3"-2 1/2"   | 76/63  | 92,4 | 91,0           | 77,5 390 |
| 4"-3"       | 101/76 | 92,4 | 119,0          | 91,0 775 |

## REDUCERS – TEES – CROSSES

- Made from cold-rolled electrojointed and solution heat-treated pipe.
- Gauged inside and outside to obtain suitable roundness.
- Faced on the ends to ensure perfect right angles of planes.
- Standard production: 1/2" – 4". Up to 8" on request.
- On request, production in conformity with DIN and ISO standards.
- Material certification and roughness tests available on request.

RIDUZIONE ECC. EL.  
 ECC. REDUCER PE.  
 RÉDUCTION EXC. BL.  
 REDUCCIÓN EXC. EL.

### W32

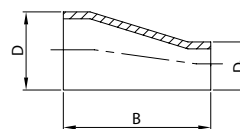

| DN        | B      | D    | D <sub>1</sub> | gr       |
|-----------|--------|------|----------------|----------|
| 3/4"-1/2" | 19/12  | 25,4 | 19,0           | 12,7 50  |
| 1"-1/2"   | 25/12  | 25,4 | 25,4           | 12,7 80  |
| 1"-3/4"   | 25/19  | 25,4 | 25,4           | 19,0 80  |
| 1 1/2"-1" | 38/25  | 67,0 | 38,1           | 25,4 110 |
| 2"-1 1/2" | 51/38  | 67,0 | 50,8           | 38,1 150 |
| 2 1/2"-2" | 63/51  | 67,0 | 63,5           | 50,8 170 |
| 3"-2"     | 76/51  | 67,0 | 76,2           | 50,8 250 |
| 3"-2 1/2" | 76/63  | 67,0 | 76,2           | 63,5 230 |
| 4"-3"     | 101/76 | 67,0 | 101,6          | 76,2 510 |

RIDUZIONE ECC. E. SM.  
 ECC. REDUCER E. FR.  
 RÉDUCTION EXC. B. FR.  
 REDUCCIÓN EXC. E. SM.

### K32

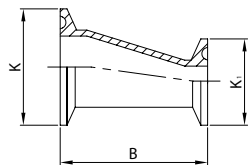

| DN        | B      | K    | K <sub>1</sub> | gr       |
|-----------|--------|------|----------------|----------|
| 3/4"-1/2" | 19/12  | 50,8 | 25,0           | 25,0 80  |
| 1"-1/2"   | 25/12  | 50,8 | 50,5           | 25,0 160 |
| 1"-3/4"   | 25/19  | 50,8 | 50,5           | 25,0 160 |
| 1 1/2"-1" | 38/25  | 92,4 | 50,5           | 50,5 250 |
| 2"-1 1/2" | 51/38  | 92,4 | 64,0           | 50,5 260 |
| 2 1/2"-2" | 63/51  | 92,4 | 77,5           | 64,0 300 |
| 3"-2"     | 76/51  | 92,4 | 91,0           | 64,0 400 |
| 3"-2 1/2" | 76/63  | 92,4 | 91,0           | 77,5 400 |
| 4"-3"     | 101/76 | 92,4 | 119,0          | 91,0 790 |



## RÉDUCTIONS - TÉS - CROIX

- Obtenus à partir de tubes électrosoudés, laminés à froid et solubilisés.
- Calibrés à l'intérieur et à l'extérieur afin d'obtenir une bonne circularité.
- Façonnés aux extrémités pour assurer l'orthogonalité parfaite des plans.
- Production standard: 1/2" - 4"; sur demande, dimensions jusqu'à 8".
- Sur demande, production conforme aux normes DIN et ISO.
- Certifications des matériaux et tests de rugosité disponibles sur demande.

TEE EL.  
 TEE PE.  
 TÉ BL.  
 TE EL.

**W7**

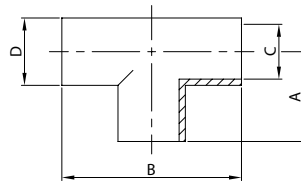

| DN     | A   | B    | C     | D    | gr        |
|--------|-----|------|-------|------|-----------|
| 1/2"   | 12  | 53,9 | 107,8 | 9,4  | 12,7 56   |
| 3/4"   | 19  | 53,9 | 107,8 | 15,7 | 19,0 98   |
| 1"     | 25  | 28,6 | 57,2  | 22,1 | 25,4 80   |
| 1 1/2" | 38  | 42,1 | 84,2  | 34,8 | 38,1 160  |
| 2"     | 51  | 52,4 | 104,8 | 47,5 | 50,8 235  |
| 2 1/2" | 63  | 59,5 | 119,0 | 60,2 | 63,5 340  |
| 3"     | 76  | 65,9 | 131,8 | 72,9 | 76,2 500  |
| 4"     | 101 | 87,3 | 174,6 | 97,4 | 101,6 900 |

TEE E. SM.  
 TEE E. FR.  
 TÉ B. FR.  
 TE E. SM.

**K7**

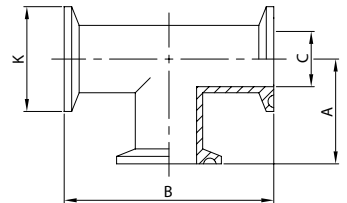

| DN     | A   | B     | C     | K    | gr          |
|--------|-----|-------|-------|------|-------------|
| 1/2"   | 12  | 66,6  | 133,2 | 9,4  | 25,0 104    |
| 3/4"   | 19  | 66,6  | 133,2 | 15,7 | 25,0 150    |
| 1"     | 25  | 60,3  | 120,6 | 22,1 | 50,5 175    |
| 1 1/2" | 38  | 69,9  | 139,8 | 34,8 | 50,5 315    |
| 2"     | 51  | 88,9  | 177,8 | 47,5 | 64,0 628    |
| 2 1/2" | 63  | 88,9  | 177,8 | 60,2 | 77,5 780    |
| 3"     | 76  | 95,3  | 190,6 | 72,9 | 91,0 1.135  |
| 4"     | 101 | 114,3 | 228,6 | 97,4 | 119,0 1.760 |

## REDUCCIONES - TES - CRUCES

- Obtenidas a partir de tubos unidos eléctricamente, laminados en frío y solubilizados.
- Calibradas interior y exteriormente con la finalidad de obtener una forma circular perfecta.
- Trabajadas en los extremos para asegurar que las superficies sean perfectamente ortogonales.
- Producción estándar: 1/2" - 4"; a pedido, dimensiones de hasta 8".
- A pedido, producción según normas DIN e ISO.
- Certificaciones de materiales y tests de rugosidad disponibles a pedido.

CROCE EL.  
 CROSS PE.  
 CROIX BL.  
 CRUZ EL.

**W9**

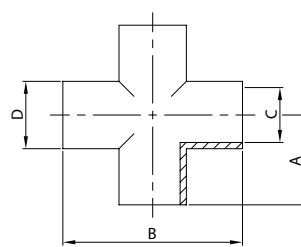

| DN     | A   | B    | C     | D    | gr          |
|--------|-----|------|-------|------|-------------|
| 1/2"   | 12  | 53,9 | 107,8 | 9,4  | 12,7 75     |
| 3/4"   | 19  | 53,9 | 107,8 | 15,7 | 19,0 130    |
| 1"     | 25  | 28,6 | 57,2  | 22,1 | 25,4 108    |
| 1 1/2" | 38  | 42,1 | 84,2  | 34,8 | 38,1 220    |
| 2"     | 51  | 52,4 | 104,8 | 47,5 | 50,8 320    |
| 2 1/2" | 63  | 59,5 | 119,0 | 60,2 | 63,5 460    |
| 3"     | 76  | 65,9 | 131,8 | 72,9 | 76,2 668    |
| 4"     | 101 | 87,3 | 174,6 | 97,4 | 101,6 1.200 |

CROCE E. SM.  
 CROSS E. FR.  
 CROIX B. FR.  
 CRUZ E. SM.

**K9**

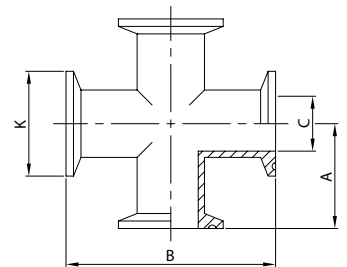

| DN     | A   | B     | C     | K    | gr          |
|--------|-----|-------|-------|------|-------------|
| 1/2"   | 12  | 66,6  | 133,2 | 9,4  | 25,0 138    |
| 3/4"   | 19  | 66,6  | 133,2 | 15,7 | 25,0 200    |
| 1"     | 25  | 60,3  | 120,6 | 22,1 | 50,5 260    |
| 1 1/2" | 38  | 69,9  | 139,8 | 34,8 | 50,5 400    |
| 2"     | 51  | 88,9  | 177,8 | 47,5 | 64,0 715    |
| 2 1/2" | 63  | 88,9  | 177,8 | 60,2 | 77,5 810    |
| 3"     | 76  | 95,3  | 190,6 | 72,9 | 91,0 1.265  |
| 4"     | 101 | 114,3 | 228,6 | 97,4 | 119,0 1.880 |



## CURVE

- Ricavate da tubi elettrouniti laminati a freddo e solubilizzati.
- Calibrate internamente ed esternamente al fine di ottenere una buona circolarità.
- Intestate alle estremità per assicurare la perfetta ortogonalità dei piani.
- Produzione standard: 1/2" - 4"; a richiesta, dimensioni fino a 8".
- A richiesta, produzione a norme DIN e ISO.
- Certificazioni di materiale e test di rugosità disponibili su richiesta.

**CURVA 45° EL.  
BEND 45° PE.  
COUDE 45° BL.  
CODO 45° EL.**

### W2K

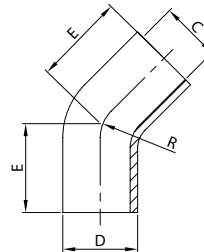

| DN     | C   | D    | E     | R     | gr        |
|--------|-----|------|-------|-------|-----------|
| 1/2"   | 12  | 9,4  | 12,7  | 57,1  | 44,4 40   |
| 3/4"   | 19  | 15,7 | 19,0  | 57,1  | 66,5 75   |
| 1"     | 25  | 22,1 | 25,4  | 30,2  | 38,1 50   |
| 1 1/2" | 38  | 34,8 | 38,1  | 41,3  | 57,2 100  |
| 2"     | 51  | 47,5 | 50,8  | 58,7  | 76,2 180  |
| 2 1/2" | 63  | 60,2 | 63,5  | 76,2  | 95,3 200  |
| 3"     | 76  | 72,9 | 76,2  | 93,7  | 114,3 500 |
| 4"     | 101 | 97,4 | 101,6 | 122,3 | 152,4 800 |

**CURVA 45° E. SM.  
BEND 45° E. FR.  
COUDE 45° B. FR.  
CODO 45° E. SM.**

### K2K

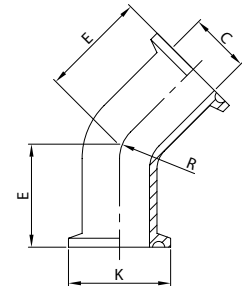

| DN     | C   | E    | K    | R     | gr          |
|--------|-----|------|------|-------|-------------|
| 1/2"   | 12  | 9,4  | 69,8 | 25,0  | 44,4 70     |
| 3/4"   | 19  | 15,7 | 69,8 | 25,0  | 66,5 100    |
| 1"     | 25  | 22,1 | 28,6 | 50,5  | 38,1 120    |
| 1 1/2" | 38  | 34,8 | 36,5 | 50,5  | 57,2 141    |
| 2"     | 51  | 47,5 | 44,5 | 64,0  | 76,2 227    |
| 2 1/2" | 63  | 60,2 | 52,4 | 77,5  | 95,3 259    |
| 3"     | 76  | 72,9 | 60,3 | 91,0  | 114,3 540   |
| 4"     | 101 | 97,4 | 79,4 | 119,0 | 152,4 1.020 |



## BENDS

- Made from cold-rolled electrojointed and solution heat-treated pipe.
- Gauged inside and outside to obtain suitable roundness.
- Faced on the ends to ensure perfect right angles of planes.
- Standard production: 1/2" - 4". Up to 8" on request.
- On request, production in conformity with DIN and ISO standards.
- Material certification and roughness tests available on request.





## COUDES

- Obtenus à partir de tubes électrosoudés, laminés à froid et solubilisés.
- Calibrés à l'intérieur et à l'extérieur afin d'obtenir une bonne circularité.
- Façonnés aux extrémités pour assurer l'orthogonalité parfaite des plans.
- Production standard: 1/2" - 4"; sur demande, dimensions jusqu'à 8".
- Sur demande, production conforme aux normes DIN et ISO.
- Certifications des matériaux et tests de rugosité disponibles sur demande.

CURVA 90° ES.  
BEND 90° WE.  
COUDE 90° BS.  
CODO 90° ES.

### W2C

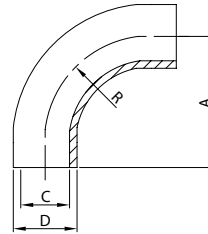

| DN     | A   | C     | D    | R     | gr    |
|--------|-----|-------|------|-------|-------|
| 1/2"   | 12  | 76,2  | 9,4  | 12,7  | 44,4  |
| 3/4"   | 19  | 76,2  | 15,7 | 19,0  | 66,5  |
| 1"     | 25  | 52,4  | 22,1 | 25,4  | 38,1  |
| 1 1/2" | 38  | 74,6  | 34,8 | 38,1  | 57,2  |
| 2"     | 51  | 103,2 | 47,5 | 50,8  | 76,2  |
| 2 1/2" | 63  | 131,8 | 60,2 | 63,5  | 95,3  |
| 3"     | 76  | 160,3 | 72,9 | 76,2  | 114,3 |
| 4"     | 101 | 211,1 | 97,4 | 101,6 | 152,4 |

CURVA 90° E. SM.  
BEND 90° E. FR.  
COUDE 90° B. FR.  
CODO 90° E. SM.

### K2C

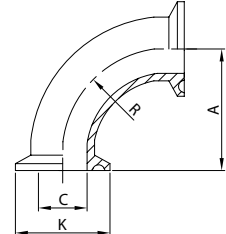

| DN     | A   | C     | K    | R     | gr    |
|--------|-----|-------|------|-------|-------|
| 1/2"   | 12  | 88,9  | 9,4  | 25,0  | 44,4  |
| 3/4"   | 19  | 88,9  | 15,7 | 25,0  | 66,5  |
| 1"     | 25  | 50,8  | 22,1 | 50,5  | 38,1  |
| 1 1/2" | 38  | 69,9  | 34,8 | 50,5  | 57,2  |
| 2"     | 51  | 88,9  | 47,5 | 64,0  | 76,2  |
| 2 1/2" | 63  | 108,0 | 60,2 | 77,5  | 95,3  |
| 3"     | 76  | 127,0 | 72,9 | 91,0  | 114,3 |
| 4"     | 101 | 168,3 | 97,4 | 119,0 | 152,4 |

## CODOS

- Obtenidos a partir de tubos unidos eléctricamente, laminados en frío y solubilizados.
- Calibrados interior y exteriormente con la finalidad de obtener una forma circular perfecta.
- Trabajados en los extremos para asegurar que las superficies sean perfectamente ortogonales.
- Producción estándar: 1/2" - 4"; a pedido, dimensiones de hasta 8".
- A pedido, producción según normas DIN e ISO.
- Certificaciones de materiales y tests de rugosidad disponibles a pedido.

CURVA 180° EL.  
BEND 180° PE.  
COUDE 180° BL.  
CODO 180° EL.

### W3C

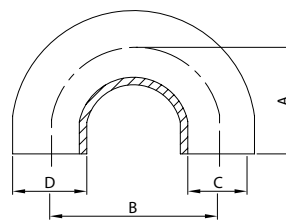

| DN     | A   | B     | C     | D    | gr    |
|--------|-----|-------|-------|------|-------|
| 1"     | 25  | 75,0  | 81,0  | 22,1 | 170   |
| 1 1/2" | 38  | 90,0  | 104,0 | 34,8 | 320   |
| 2"     | 51  | 100,0 | 143,0 | 47,5 | 500   |
| 2 1/2" | 63  | 115,0 | 168,0 | 60,2 | 740   |
| 3"     | 76  | 130,0 | 171,0 | 72,9 | 1.180 |
| 4"     | 101 | 150,0 | 220,0 | 97,4 | 1.980 |

CURVA 180° E. SM.  
BEND 180° E. FR.  
COUDE 180° B. FR.  
CODO 180° E. SM.

### K3C

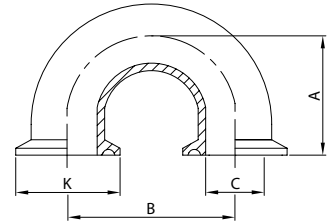

| DN     | A   | B     | C     | K    | gr    |
|--------|-----|-------|-------|------|-------|
| 1"     | 25  | 87,7  | 81,0  | 22,1 | 340   |
| 1 1/2" | 38  | 102,7 | 104,0 | 34,8 | 400   |
| 2"     | 51  | 112,7 | 143,0 | 47,5 | 740   |
| 2 1/2" | 63  | 127,7 | 168,0 | 60,2 | 1.000 |
| 3"     | 76  | 142,7 | 171,0 | 72,9 | 1.820 |
| 4"     | 101 | 165,8 | 220,0 | 97,4 | 3.320 |



## FILTRI

- Parti filtranti facilmente estraibili.
- Produzione standard: cartucce filtranti in lamiera con fori da 1 mm. A richiesta, disponibili con fori da 0,5 mm, 2 mm o 3 mm ed eventuale copertura con rete metallica da 80 a 500 mesh.
- Max. pressione di esercizio: 5 bar.

## FILTERS

- Filtering parts easily extractable.
- Standard production: sheet metal filter cartridges with 1 mm holes. On request available with 0.5 mm, 2 mm or 3 mm holes and metal screen cover from 80 to 500 meshes.
- Maximum operating pressure: 5 bars.

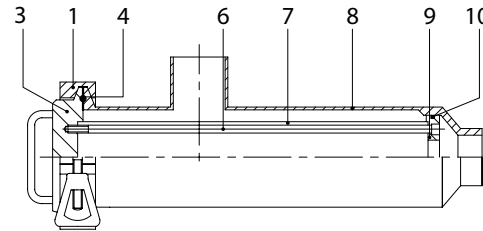
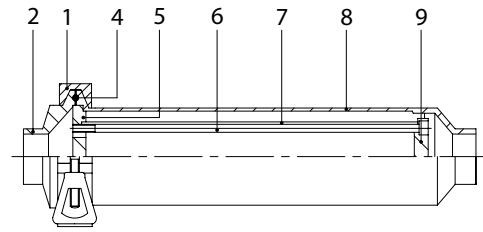

- |   |  |
|---|--|
| 1. Morsetto Clamp<br>Clamp<br>Collier Clamp<br>Abrazadera Clamp           | 6. Tirante<br>Tie rod<br>Tirant<br>Tirante                             |
| 2. Riduzione Clamp<br>Clamp reducer<br>Réduction Clamp<br>Reducción Clamp | 7. Rete filtro<br>Filter<br>Tamis<br>Red filtro                        |
| 3. Tappo speciale<br>Blank<br>Bouchon à poignée<br>Tapón especial         | 8. Corpo filtro<br>Filter casing<br>Corps du filtre<br>Cuerpo filtro   |
| 4. Guarnizione<br>Seal<br>Joint<br>Junta                                  | 9. Disco inferiore<br>Lower disk<br>Disque inférieur<br>Disco inferior |
| 5. Disco superiore<br>Upper disk<br>Disque supérieur<br>Disco superior    | 10. Anello di tenuta OR<br>OR seal ring<br>Joint torique<br>Junta OR   |



PORTATA M<sup>3</sup>/H  
FLOWRATE M<sup>3</sup>/H  
DÉBIT M<sup>3</sup>/H  
CAUDAL M<sup>3</sup>/H

| Diametro<br>Diameter<br>Diametre<br>Diametro | Velocità del fluido m/sec<br>Fluid speed m/sec<br>Vitesse du fluide m/sec<br>Velocidad del fluido m/sec |        |        |        |
|--|---|--------|--------|--------|
|  | 0,50  | 1,00   | 1,50   | 2,00   |
| 25,4   | 0,745   | 1,494  | 2,239  | 2,988  |
| 38,1   | 1,785   | 3,571  | 5,356  | 7,142  |
| 50,8   | 3,294   | 6,588  | 9,882  | 13,176 |
| 63,5   | 5,191   | 10,382 | 15,573 | 20,764 |
| 76,2   | 7,509   | 15,019 | 22,528 | 30,038 |
| 101,6  | 14,130  | 28,260 | 42,390 | 56,520 |



## FILTRES

- Parties filtrantes facilement extractibles.
- Production standard: cartouches filtrantes en tôle avec trous de 1 mm. Sur demande, disponibles avec trous de 0,5 mm, 2 mm ou 3 mm et éventuelle couverture avec une grille métallique de 80 à 500 mesh.
- Pression d'exploitation maximum: 5 bars.

## FILTROS

- Las piezas filtrantes se pueden extraer fácilmente.
- Producción estándar: cartuchos filtrantes de chapa con orificios de 1 mm. A pedido, se pueden suministrar con orificios de 0,5 mm, 2 mm o 3 mm y, eventualmente, con cobertura de red metálica de 80 a 500 mesh.
- Máxima presión de ejercicio: 5 bares.

**PERDITE DI CARICO**  
**PRESSURE DROP**  
**PERTES DE CHARGE**  
**PÉRDIDA DE CARGA**

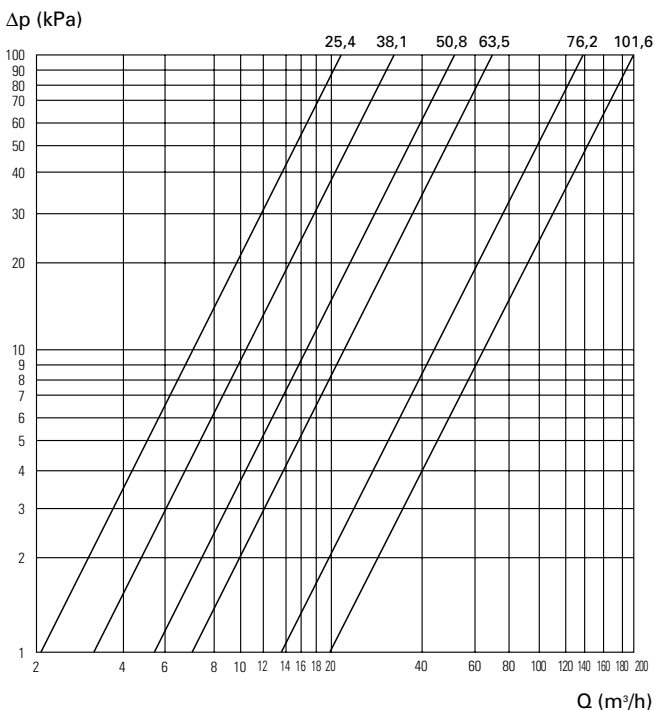

**FILTRO LINEA EL.**  
**LINE FILTER PE.**  
**FILTRE DROIT BL.**  
**FILTRO LÍNEA EL.**

### W42

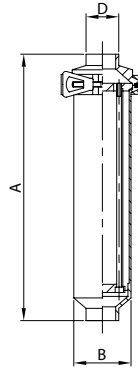

| DN        | A     | B     | D    | gr    |
|-----------|-------|-------|------|-------|
| 1" 25     | 326,0 | 70,0  | 25,4 | 3.000 |
| 1 1/2" 38 | 326,0 | 70,0  | 38,1 | 3.000 |
| 2" 51     | 426,0 | 70,0  | 50,8 | 3.300 |
| 2 1/2" 63 | 524,5 | 85,0  | 63,5 | 4.650 |
| 3" 76     | 568,0 | 101,0 | 76,2 | 5.700 |

**FILTRO LINEA E. SM.**  
**LINE FILTER E. FR.**  
**FILTRE DROIT B. FR.**  
**FILTRO LÍNEA E. SM.**

### K42

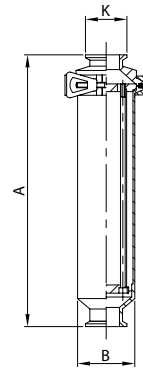

| DN        | A     | B     | K    | gr    |
|-----------|-------|-------|------|-------|
| 1" 25     | 326,0 | 70,0  | 50,5 | 3.170 |
| 1 1/2" 38 | 326,0 | 70,0  | 50,5 | 3.300 |
| 2" 51     | 426,0 | 70,0  | 64,0 | 3.620 |
| 2 1/2" 63 | 524,5 | 85,0  | 77,5 | 5.190 |
| 3" 76     | 568,0 | 101,0 | 91,0 | 6.400 |

**FILTRO 90° EL.**  
**90° FILTER PE.**  
**FILTRE 90° BL.**  
**FILTRO 90° EL.**

### W43

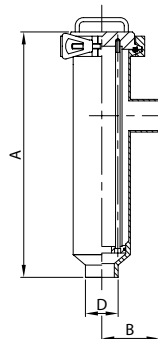

| DN        | A     | B    | D    | gr    |
|-----------|-------|------|------|-------|
| 1" 25     | 304,0 | 70,0 | 25,4 | 3.100 |
| 1 1/2" 38 | 304,0 | 70,0 | 38,1 | 3.100 |
| 2" 51     | 404,0 | 72,0 | 50,8 | 3.400 |
| 2 1/2" 63 | 497,0 | 85,0 | 63,5 | 4.800 |
| 3" 76     | 548,0 | 96,0 | 76,2 | 5.900 |

**FILTRO 90° E. SM.**  
**90° FILTER E. FR.**  
**FILTRE 90° B. FR.**  
**FILTRO 90° E. SM.**

### K43

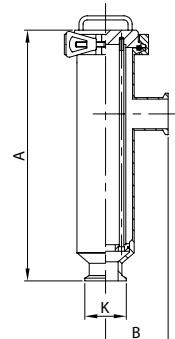

| DN        | A     | B     | K    | gr    |
|-----------|-------|-------|------|-------|
| 1" 25     | 304,0 | 82,7  | 50,5 | 3.240 |
| 1 1/2" 38 | 304,0 | 82,7  | 50,5 | 3.500 |
| 2" 51     | 404,0 | 84,7  | 64,0 | 3.850 |
| 2 1/2" 63 | 497,0 | 97,7  | 77,5 | 5.590 |
| 3" 76     | 548,0 | 108,7 | 91,0 | 6.900 |



## SPECOLE

- Di solida e robusta costruzione.
- Vetro in pyrex; a richiesta, protezione esterna in plexiglas.
- Corredate di speciali tiranti e guarnizioni per eliminare le pressioni di carico e le vibrazioni sul vetro.
- Max. pressione di esercizio: 10 bar.

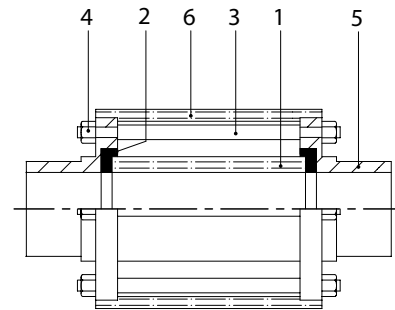

## SIGHT GLASSES

- High strength construction.
- Pyrex glass. On request plexiglas external guard.
- Equipped with special tie rods and seals to prevent load pressure and vibrations on the glass.
- Maximum operating pressure: 10 bars.

- |  |   |
|--|---|
| 1. Tubo vetro<br>Glass pipe<br>Tube pyrex<br>Pyrex | 4. Dado autobloccante<br>Self-locking nut<br>Écrou de sûreté<br>Tuerca de seguridad |
| 2. Guarnizione<br>Seal<br>Joint<br>Junta           | 5. Flangia<br>Flange<br>Bride<br>Brida  |
| 3. Tirante<br>Tie rod<br>Tirant<br>Tirante         | 6. Protezione<br>Guard<br>Protection<br>Protección                                  |

## REGARDS

- Fabrication solide et robuste.
- Verre en pyrex. Sur demande, protection externe en plexiglas.
- Munis de tirants spéciaux et de joints pour éliminer les pressions de charge et les vibrations sur le verre.
- Pression d'exploitation maximum: 10 bars.

**SPECOLE EL.**  
**SIGHT GLASS PE.**  
**REGARD BL.**  
**MIRILLA EL.**

### W45

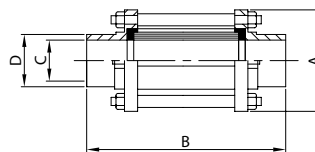

| DN        | A     | B     | C    | D     | gr    |
|-----------|-------|-------|------|-------|-------|
| 1" 25     | 55,0  | 147,0 | 22,1 | 25,4  | 400   |
| 1 1/2" 38 | 70,0  | 153,0 | 34,8 | 38,1  | 620   |
| 2" 51     | 85,0  | 153,0 | 47,5 | 50,8  | 860   |
| 2 1/2" 63 | 95,0  | 163,0 | 60,2 | 63,5  | 950   |
| 3" 76     | 105,0 | 173,0 | 72,9 | 76,2  | 1.100 |
| 4" 101    | 140,0 | 173,0 | 97,4 | 101,6 | 2.760 |

**SPECOLE E. SM.**  
**SIGHT GLASS E. FR.**  
**REGARD B. FR.**  
**MIRILLA E. SM.**

### K45

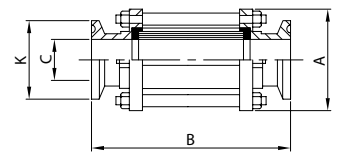

| DN        | A     | B     | C    | K     | gr    |
|-----------|-------|-------|------|-------|-------|
| 1" 25     | 55,0  | 165,0 | 22,1 | 50,5  | 560   |
| 1 1/2" 38 | 70,0  | 165,0 | 34,8 | 50,5  | 760   |
| 2" 51     | 85,0  | 165,0 | 47,5 | 64,0  | 1.050 |
| 2 1/2" 63 | 95,0  | 165,0 | 60,2 | 77,5  | 1.180 |
| 3" 76     | 105,0 | 165,0 | 72,9 | 91,0  | 1.400 |
| 4" 101    | 140,0 | 165,0 | 97,4 | 119,0 | 3.260 |

## MIRILLAS

- Fabricación sólida y robusta.
- Vidrio pyrex. A pedido, protección exterior de plexiglás.
- Equipadas con tirantes especiales y con juntas para eliminar las presiones de carga y las vibraciones sobre el vidrio.
- Máxima presión de ejercicio: 10 bares.





## RUBINETTI

- Ricavati da particolari completi di attacchi stampati a caldo o laminati e solubilizzati.
- Realizzati seguendo rigorosamente i criteri e i test imposti dalle norme 3-A.
- Ricopertura dei maschi in bagno galvanico con riporto di cromo durissimo e di elevato spessore.
- Elevato grado di conicità negli accoppiamenti per diminuire la pressione specifica di rotazione dei maschi.
- Max. pressione di esercizio: 4 bar.

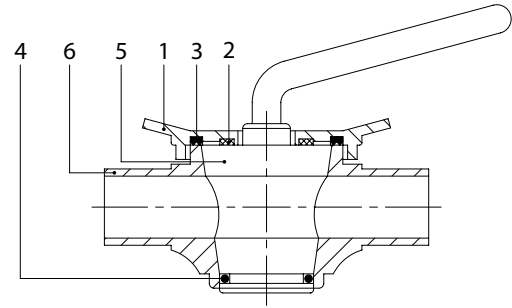

## PLUG COCKS

- Made from sections complete with couplings, press-forged or hot-rolled and solution heat-treated.
- Produced in strict conformity with criteria and tests required by 3-A standards.
- Plugs coated in galvanic bath with very hard and thick chrome deposit.
- High degree of taper in the couplings to reduce specific rotation pressure of plugs.
- Maximum operating pressure: 4 bars.

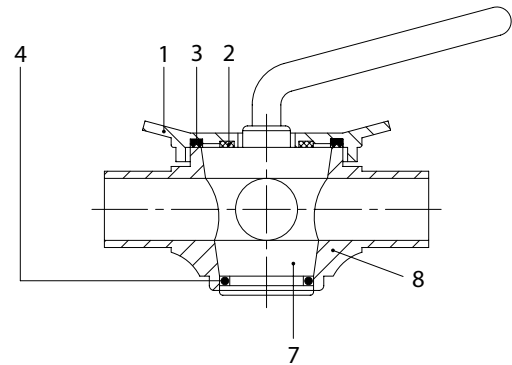

## ROBINETS

- Obtenus à partir de pièces munies de prises moulées à chaud ou laminées et solubilisées.
- Réalisés en respectant scrupuleusement les critères et les tests imposés par les normes 3-A.
- Revêtement des boisseaux dans bain galvanique avec report de chrome extrêmement dure et fort épais.
- Niveau de conicité élevé des assemblages afin de diminuer la pression de rotation spécifique des boisseaux.
- Pression d'exploitation maximum: 4 bars.

- |   |   |
|---|---|
| 1. Coperchio<br>Cover<br>Couvercle<br>Tapa                          | 5. Maschio 2 vie<br>Two-way plug<br>Boisseau 2 voies<br>Macho 2 vías                              |
| 2. Anello PTFE<br>PTFE ring<br>Bague PTFE<br>Junta PTFE             | 6. Corpo rubinetto 2 vie<br>Two-way plug casing<br>Corps robinet 2 voies<br>Cuerpo grifo 2 vías   |
| 3. Guarnizione a W<br>W seal<br>Joint W<br>Junta W                  | 7. Maschio 3 vie<br>Three-way plug<br>Boisseau 3 voies<br>Macho 3 vías                            |
| 4. Anello di tenuta OR<br>OR seal ring<br>Joint torique<br>Junta OR | 8. Corpo rubinetto 3 vie<br>Three-way plug casing<br>Corps robinet 3 voies<br>Cuerpo grifo 3 vías |

## GRIFOS

- Obtenidos de piezas provistas de conexiones estampadas en caliente o laminadas y solubilizadas.
- Realizados respetando rigurosamente los criterios y los tests establecidos por las normas 3-A.
- Recubrimiento de los machos en baño galvánico con agregado de cromo durísimo y de elevado espesor.
- Elevado grado de conicidad en los acoplamientos para disminuir la presión específica de rotación de los machos.
- Máxima presión de ejercicio: 4 bares.



**RUBINETTO 2 VIE EL.**  
**2-WAY PLUG COCK PE.**  
**ROBINET 2 VOIES BL.**  
**GRIFO 2 VÍAS EL.**

**W10**

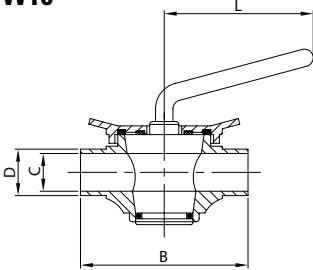

| DN        | B     | C    | D    | L     | gr     |
|-----------|-------|------|------|-------|--------|
| 1" 25     | 125,0 | 22,1 | 25,4 | 100,0 | 1.950  |
| 1 1/2" 38 | 160,0 | 34,8 | 38,1 | 115,0 | 4.250  |
| 2" 51     | 170,0 | 47,5 | 50,8 | 140,0 | 6.050  |
| 2 1/2" 63 | 200,0 | 60,2 | 63,5 | 160,0 | 12.600 |
| 3" 76     | 230,0 | 72,9 | 76,2 | 160,0 | 16.150 |

**RUBINETTO 2 VIE E. SM.**  
**2-WAY PLUG COCK E. FR.**  
**ROBINET 2 VOIES B. FR.**  
**GRIFO 2 VÍAS E. SM.**

**K10**

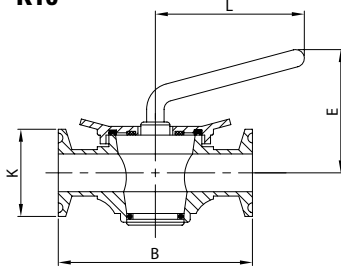

| DN        | B     | E     | K    | L     | gr     |
|-----------|-------|-------|------|-------|--------|
| 1" 25     | 125,0 | 90,0  | 50,5 | 100,0 | 1.930  |
| 1 1/2" 38 | 160,0 | 117,0 | 50,5 | 115,0 | 4.270  |
| 2" 51     | 170,0 | 122,0 | 64,0 | 140,0 | 6.450  |
| 2 1/2" 63 | 200,0 | 142,0 | 77,5 | 160,0 | 14.300 |
| 3" 76     | 230,0 | 154,0 | 91,0 | 160,0 | 18.400 |

**RUBINETTO 3 VIE EL.**  
**3-WAY PLUG COCK PE.**  
**ROBINET 3 VOIES BL.**  
**GRIFO 3 VÍAS EL.**

**W11**

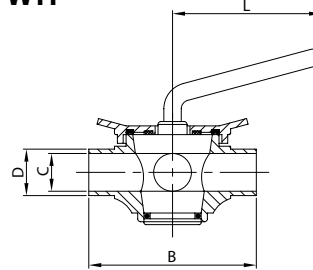

| DN        | B     | C    | D    | L     | gr     |
|-----------|-------|------|------|-------|--------|
| 1" 25     | 125,0 | 22,1 | 25,4 | 100,0 | 2.050  |
| 1 1/2" 38 | 160,0 | 34,8 | 38,1 | 115,0 | 4.450  |
| 2" 51     | 170,0 | 47,5 | 50,8 | 140,0 | 6.100  |
| 2 1/2" 63 | 200,0 | 60,2 | 63,5 | 160,0 | 12.350 |
| 3" 76     | 230,0 | 72,9 | 76,2 | 160,0 | 17.000 |

**RUBINETTO 3 VIE E. SM.**  
**3-WAY PLUG COCK E. FR.**  
**ROBINET 3 VOIES B. FR.**  
**GRIFO 3 VÍAS E. SM.**

**K11**

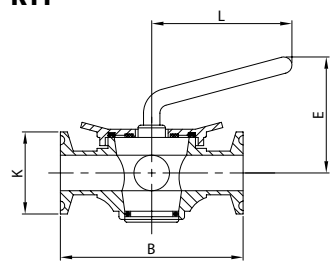

| DN        | B     | E     | K    | L     | gr     |
|-----------|-------|-------|------|-------|--------|
| 1" 25     | 125,0 | 90,0  | 50,5 | 100,0 | 2.370  |
| 1 1/2" 38 | 160,0 | 117,0 | 50,5 | 115,0 | 4.880  |
| 2" 51     | 170,0 | 122,0 | 64,0 | 140,0 | 6.940  |
| 2 1/2" 63 | 200,0 | 142,0 | 77,5 | 160,0 | 13.250 |
| 3" 76     | 230,0 | 154,0 | 91,0 | 160,0 | 16.530 |

**PORTALIVELLO SUP. NPT**  
**UPPER LEVEL GAUGE NPT**  
**M. SUP. DE NIVEAU NPT**  
**GRIFO NIVEL SUP. NPT**

**T47**

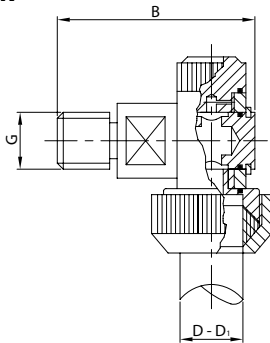

| DN        | B    | D    | D <sub>1</sub> | G    | gr  |
|-----------|------|------|----------------|------|-----|
| 1 1/2" 38 | 66,5 | 22,0 | 16,0           | 3/8" | 275 |

**PORTALIVELLO SUP. E. SM.**  
**UPPER LEVEL GAUGE E. FR.**  
**M. SUP. DE NIVEAU B. FR.**  
**GRIFO NIVEL SUP. E. SM.**

**K47**

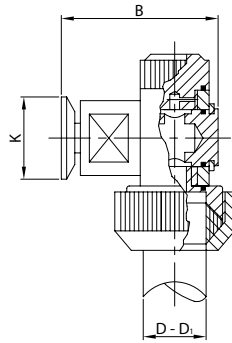

| DN    | B    | D    | D <sub>1</sub> | K    | gr  |
|-------|------|------|----------------|------|-----|
| 1" 25 | 56,5 | 22,0 | 16,0           | 50,5 | 300 |

**RUB. PORTALIVELLO NPT**  
**LOWER LEVEL GAUGE NPT**  
**ROB. DE NIVEAU NPT**  
**GRIFO NIVEL NPT**

**T38**

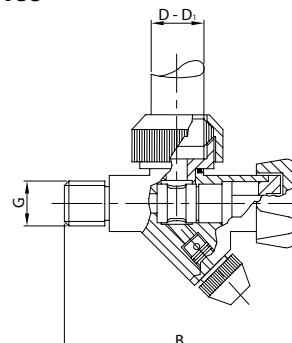

| DN        | B     | D    | D <sub>1</sub> | G    | gr  |
|-----------|-------|------|----------------|------|-----|
| 1 1/2" 38 | 110,0 | 22,0 | 16,0           | 3/8" | 515 |

**RUB. PORTALIVELLO E. SM.**  
**LOWER LEVEL GAUGE E. FR.**  
**ROB. DE NIVEAU B. FR.**  
**GRIFO NIVEL E. SM.**

**K38**

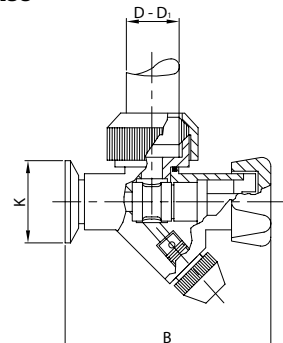

| DN        | B    | D    | D <sub>1</sub> | K    | gr  |
|-----------|------|------|----------------|------|-----|
| 1 1/2" 25 | 99,0 | 22,0 | 16,0           | 50,5 | 530 |

**RUB. PRELIEVO NPT**  
**SAMPLING PLUG NPT**  
**R. PRISE ÉCHANTILLON NPT**  
**GRIFO TOMAM. NPT**

**T33**

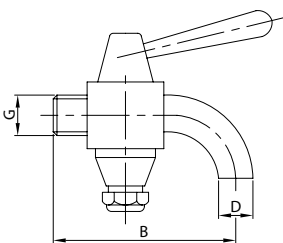

| DN        | B    | D    | G    | gr  |
|-----------|------|------|------|-----|
| 1 1/2" 38 | 60,0 | 11,0 | 3/8" | 185 |

**RUB. PRELIEVO E. SM.**  
**SAMPLING PLUG E. FR.**  
**R. PRISE ÉCHANTIL. B. FR.**  
**GRIFO TOMAM. E. SM.**

**K33**

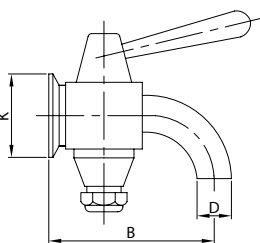

| DN    | B    | D    | K    | gr  |
|-------|------|------|------|-----|
| 1" 25 | 58,0 | 11,0 | 50,5 | 200 |

**RUB. PREL. SANIT. EL.**  
**SANITARY SAMPL. PLUG PE.**  
**R. PRISE E. SANIT. BL.**  
**GRIFO T. SANIT. EL.**

**W36**

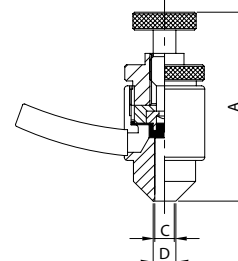

| DN        | A    | C   | D   | gr  |
|-----------|------|-----|-----|-----|
| 1 1/2" 12 | 57,6 | 6,0 | 8,0 | 120 |

**RUB. PREL. SANIT. E. SM.**  
**SANIT. SAMPL. PLUG E. FR.**  
**R. PRISE E. SANIT. B. FR.**  
**GRIFO T. SANIT. E. SM.**

**K36**

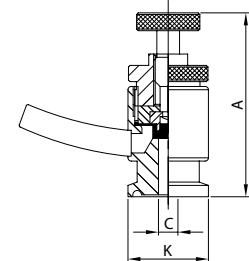

| DN        | A    | C   | K    | gr  |
|-----------|------|-----|------|-----|
| 1 1/2" 12 | 57,6 | 9,4 | 25,0 | 120 |



## VALVOLE DI REGOLAZIONE FLUSSO

- Di solida e robusta costruzione, ricavate da massello di acciaio inossidabile.
- Regolazione della portata del flusso mediante avvitamento della ghiera di regolazione.
- Albero interno in acciaio inossidabile cromato; guarnizione in EPDM.
- Max. pressione di esercizio: 15 bar.

## FLOW CONTROL VALVES

- High strength construction from solid stainless steel block.
- Flow control by screwing the external adjusting device.
- Internal stem of chrome-plated stainless steel. EPDM gasket.
- Maximum operating pressure: 15 bars.

## VANNES DE RÉGLAGE FLUX

- Fabrication solide et robuste. Réalisées à partir de blocs d'acier inoxydable.
- Réglage du débit du flux par vissage de la bague de réglage.
- Arbre interne en acier inoxydable chromé; joint en EPDM.
- Pression d'exploitation maximum: 15 bars.

## VÁLVULAS DE REGULACIÓN

- Fabricación sólida y robusta, puesto que se obtienen a partir de un lingote de acero inoxidable.
- Regulación del flujo mediante enroscado de la tuerca de regulación.
- Eje interior de acero inoxidable cromado; junta de EPDM.
- Máxima presión de ejercicio: 15 bares.

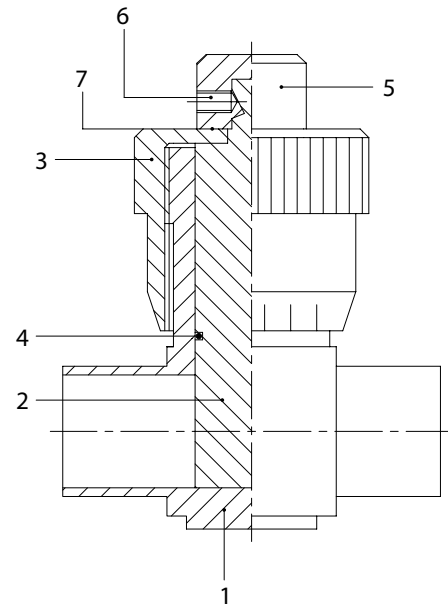

- |  |  |
|--|--|
| 1. Corpo valvola<br>Valve casing<br>Corps vanne<br>Cuerpo                                | 5. Elemento di bloccaggio<br>Locking device<br>Élément de blocage<br>Elemento de bloqueo |
| 2. Tampone<br>Head seal<br>Tampon<br>Macho   | 6. Grano<br>Dowel<br>Cheville<br>Pasador   |
| 3. Ghiera di regolazione<br>Adjusting device<br>Bague de réglage<br>Tuerca de regulación | 7. Rondella<br>Washer<br>Rondelle<br>Arandela  |
| 4. Anello di tenuta OR<br>OR seal ring<br>Joint torique<br>Junta OR                      |  |

V. REGOLAZ. FLUSSO EL.  
FLOW CONTROL V. PE.  
V. RÉGLAGE FLUX BL.  
V. REGULACIÓN EL.

V. REG. FLUSSO E. SM.  
FLOW CONTROL V. E. FR.  
V. RÉGLAGE FLUX B. FR.  
V. REGULACIÓN E. SM.

### W62

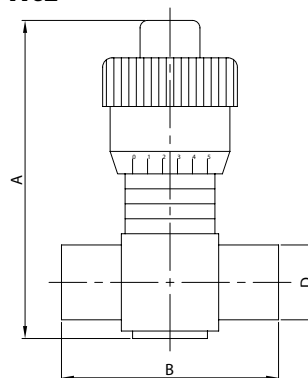

| DN        | A     | B     | D    | gr    |
|-----------|-------|-------|------|-------|
| 1" 25     | 127,0 | 83,0  | 25,4 | 1.220 |
| 1 1/2" 38 | 140,0 | 100,0 | 38,1 | 2.200 |
| 2" 51     | 165,0 | 124,0 | 50,8 | 2.820 |
| 2 1/2" 63 | 200,0 | 133,0 | 63,5 | 3.760 |
| 3" 76     | 253,0 | 145,0 | 76,2 | 7.420 |

### K62

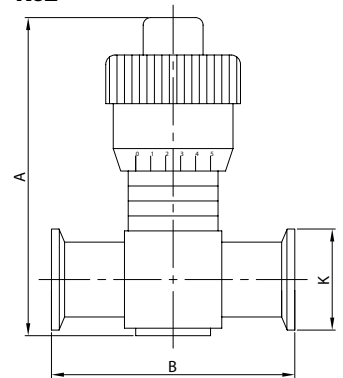

| DN        | A     | B     | K    | gr    |
|-----------|-------|-------|------|-------|
| 1" 25     | 127,0 | 100,0 | 50,5 | 1.440 |
| 1 1/2" 38 | 140,0 | 117,0 | 50,5 | 2.560 |
| 2" 51     | 165,0 | 127,0 | 64,0 | 3.150 |
| 2 1/2" 63 | 200,0 | 140,0 | 77,5 | 4.200 |
| 3" 76     | 253,0 | 152,0 | 91,0 | 8.300 |

## VALVOLE DI SICUREZZA

- Elemento di regolazione della pressione situato all'interno del corpo valvola a garanzia contro manovre accidentali.
- Regolabili da 0 a 5 bar; a richiesta, regolabili fino a 10 bar.

## RELIEF VALVES

- Pressure control element located inside valve body to prevent accidental operation.
- Adjustable from 0 to 5 bars. On request, adjustable up to 10 bars.

## SOUPAPES DE SÛRETÉ

- Bague de réglage de la pression située dans le corps de la vanne afin d'éviter tout risque de manoeuvre accidentelle.
- Réglables de 0 à 5 bars; sur demande, réglables jusqu'à 10 bars.

## VÁLVULAS DE SEGURIDAD

- Tuerca de regulación de la presión situada en el interior del cuerpo de la válvula para impedir que se produzcan maniobras accidentales.
- Se pueden regular de 0 a 5 bares; a pedido, se pueden regular hasta 10 bares.

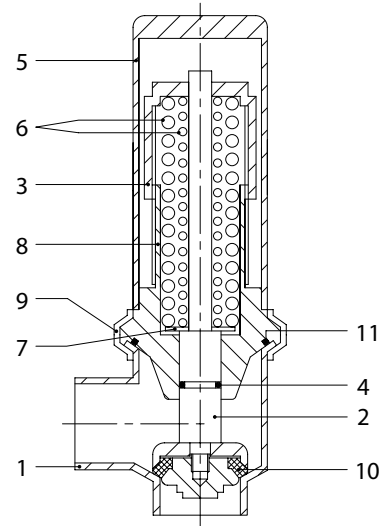

- |   |  |
|---|--|
| 1. Corpo valvola<br>Valve casing<br>Corps vanne<br>Cuerpo                               | 7. Rondella<br>Washer<br>Rondelle<br>Arandela                        |
| 2. Tampone<br>Head seal<br>Tampon<br>Macho  | 8. Elemento base<br>Main assembly<br>Élément base<br>Cuerpo interno  |
| 3. Elemento di regolazione<br>Adjusting cap<br>Bague de réglage<br>Tuerca de regulación | 9. Collare<br>Collar<br>Collier<br>Abrazadera                        |
| 4. Anello di tenuta OR<br>OR seal ring<br>Joint torique<br>Junta OR                     | 10. Guarnizione PTFE<br>PTFE seal<br>Joint PTFE<br>Junta PTFE        |
| 5. Coperchio<br>Cover<br>Couvercle<br>Tapa  | 11. Anello di tenuta OR<br>OR seal ring<br>Joint torique<br>Junta OR |
| 6. Molla<br>Spring<br>Ressort<br>Muelles  |  |

VALVOLA SICUREZZA EL.  
RELIEF VALVE PE.  
SOUPAPE SÛRETÉ BL.  
VÁLVULA SEGURIDAD EL.

V. SICUREZZA E. SM.  
RELIEF VALVE E. FR.  
S. SÛRETÉ B. FR.  
V. SEGURIDAD E. SM.

### W60 RT

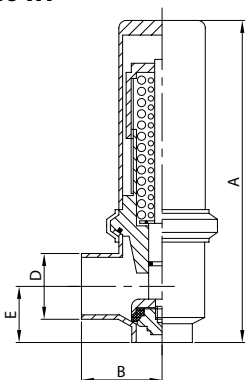

| DN        | A     | B    | D    | E    | gr    |
|-----------|-------|------|------|------|-------|
| 1" 25     | 206,0 | 60,0 | 25,4 | 43,0 | 2.185 |
| 1 1/2" 38 | 217,0 | 60,0 | 38,1 | 48,5 | 2.270 |
| 2" 51     | 232,0 | 70,0 | 50,8 | 54,0 | 2.910 |
| 2 1/2" 63 | 279,0 | 80,0 | 63,5 | 72,0 | 4.550 |
| 3" 76     | 300,0 | 90,0 | 76,2 | 90,0 | 6.100 |

### K60 RT

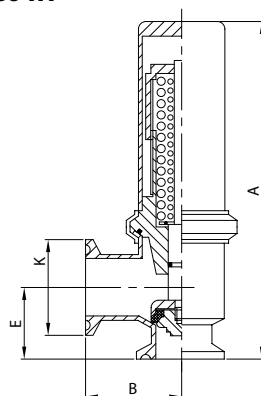

| DN        | A     | B     | E     | K    | gr    |
|-----------|-------|-------|-------|------|-------|
| 1" 25     | 218,7 | 72,7  | 55,7  | 50,5 | 2.300 |
| 1 1/2" 38 | 229,7 | 72,7  | 61,2  | 50,5 | 2.350 |
| 2" 51     | 244,7 | 82,7  | 66,7  | 64,0 | 3.030 |
| 2 1/2" 63 | 291,7 | 92,7  | 84,7  | 77,5 | 4.710 |
| 3" 76     | 312,7 | 102,7 | 102,7 | 91,0 | 6.280 |





## VALVOLE DI RITEGNO

- Di solida e robusta costruzione, ricavate da massello di acciaio inossidabile.
- Ampia apertura del diaframma per permettere il passaggio di sostanze solide.
- Guarnizioni di tenuta in PTFE o, a richiesta, altri elastomeri.
- Corredate con molle di bassa pressione che consentono il funzionamento della valvola sia in posizione verticale che orizzontale.
- Max. pressione di esercizio: 15 bar.

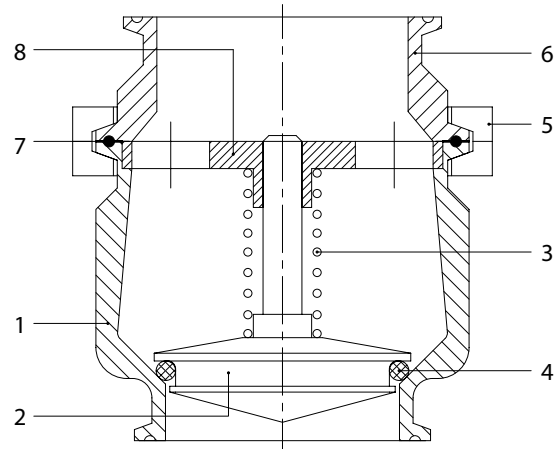

## CHECK VALVES

- High strength construction from solid stainless steel block.
- Wide diaphragm opening to permit passage of solid particles.
- PTFE sealing gasket or other elastomers on request.
- Equipped with low-pressure springs allowing either vertical or horizontal valve operation.
- Maximum operating pressure: 15 bars.

1. Corpo valvola  
Valve casing  
Corps vanne  
Cuerpo

2. Tampone  
Shutter  
Tampon  
Macho

3. Molla  
Spring  
Ressort  
Muelles

4. Guarnizione PTFE  
PTFE seal  
Joint PTFE  
Junta PTFE

5. Morsetto Clamp  
Clamp  
Collier Clamp  
Abrazadera Clamp

6. Riduzione Clamp  
Clamp reducer  
Réduction Clamp  
Reducción Clamp

7. Guarnizione  
Seal  
Joint  
Junta

8. Diaframma  
Diaphragm  
Diaphragme  
Diafragma

## CLAPETS DE RETENUE

- Fabrication solide et robuste. Réalisées à partir de blocs d'acier inoxydable.
- Large ouverture du diaphragme de façon à permettre le passage des substances solides.
- Joints d'étanchéité en PTFE ou, sur demande, avec d'autres élastomères.
- Munies de ressorts à basse pression leur permettant de fonctionner aussi bien en position verticale qu'horizontale.
- Pression d'exploitation maximum: 15 bars.

V. RITEGNO EL.  
CHECK VALVE PE.  
CLAPET RETENUE BL.  
VÁLVULA RETENCIÓN EL.

V. RITEGNO E. SM.  
CHECK VALVE E. FR.  
CLAPET RETENUE B. FR.  
VÁLV. RETENCIÓN E. SM.

### W64 V

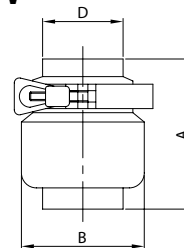

### K64 V

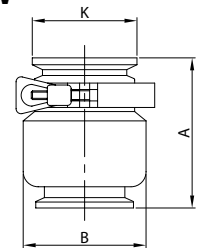

## VÁLVULAS DE RETENCIÓN

- Fabricación sólida y robusta, puesto que se obtienen a partir de un lingote de acero inoxidable.
- Amplia abertura del diafragma para permitir el paso de sustancias sólidas.
- Junta estanca de PTFE o, a pedido, otros elastómeros.
- Equipadas con muelles de baja presión que permiten el funcionamiento de la válvula tanto en posición vertical como horizontal.
- Máxima presión de ejercicio: 15 bares.

| DN      | A   | B     | D     | gr    |       |
|---------|-----|-------|-------|-------|-------|
| 1/2"    | 12  | 74,0  | 25,0  | 12,7  | 240   |
| 3/4"    | 19  | 75,0  | 40,0  | 19,0  | 520   |
| 1"      | 25  | 94,0  | 50,5  | 25,4  | 880   |
| 1" 1/2" | 38  | 95,0  | 64,0  | 38,1  | 1.070 |
| 2"      | 51  | 102,0 | 77,5  | 50,8  | 1.750 |
| 2" 1/2" | 63  | 111,0 | 91,0  | 63,5  | 2.140 |
| 3"      | 76  | 125,0 | 119,0 | 76,2  | 3.950 |
| 4"      | 101 | 136,0 | 131,0 | 101,6 | 4.900 |

| DN      | A   | B     | K     | gr    |       |
|---------|-----|-------|-------|-------|-------|
| 1/2"    | 12  | 74,0  | 25,0  | 25,0  | 260   |
| 3/4"    | 19  | 75,0  | 40,0  | 25,0  | 540   |
| 1"      | 25  | 94,0  | 50,5  | 50,5  | 900   |
| 1" 1/2" | 38  | 95,0  | 64,0  | 64,0  | 1.100 |
| 2"      | 51  | 102,0 | 77,5  | 77,5  | 1.800 |
| 2" 1/2" | 63  | 111,0 | 91,0  | 91,0  | 2.200 |
| 3"      | 76  | 125,0 | 119,0 | 119,0 | 4.020 |
| 4"      | 101 | 136,0 | 131,0 | 131,0 | 5.000 |

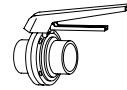

## VALVOLE A FARFALLA

- Ricavate da particolari stampati a caldo e termotrattati.
- Otturatori ricavati da particolari stampati a caldo e solubilizzati, lavorati meccanicamente su tutte le superfici e rettificati sulle parti rotanti.
- Applicazione standard di due bussole in PTFE sugli alberi degli otturatori per eliminare l'attrito nelle rotazioni.
- Guarnizioni prodotte con stampaggio a compressione e con elastomeri di ottima qualità. Standard silicone; a richiesta, EPDM, FTM, FTM rivestito PTFE, PTFE + silicone.
- Possibilità di intercambiabilità tra le varie unificazioni.
- Ampia gamma di comandi manuali per soddisfare le differenti necessità impiantistiche.
- Semplicità, sicurezza e affidabilità delle manovre.
- Comandi pneumatici orizzontali e verticali a semplice effetto, doppio effetto e di regolazione flusso, correddabili di contatto di prossimità, microinterruttore, elettrovalvola, connettore.
- Max. pressione di esercizio: 7 bar; per guarnizioni in PTFE: 2 bar.
- Produzione standard: 1"-10".

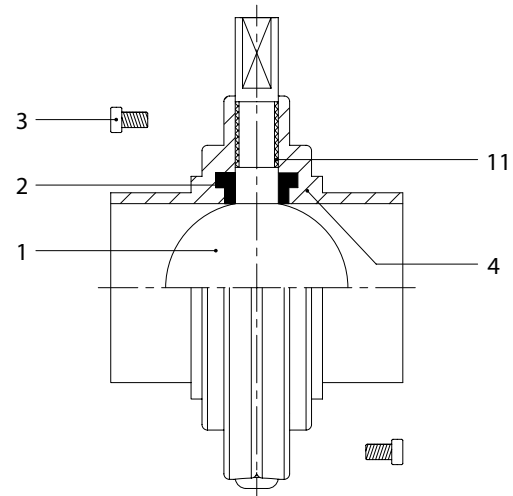

- 1. Otturatore  
Butterfly  
Papillon  
Obturador
- 2. Guarnizione  
Gasket  
Joint  
Junta
- 3. Vite  
Screw  
Vis  
Tornillo

- 4. Flangia  
Flange  
Bride  
Brida
- 11. Bussola PTFE  
PTFE bush  
Douille PTFE  
Camisa PTFE

## BUTTERFLY VALVES

- Made from press-forged and solution heat-treated blanks.
- Shutters made from press-forged and solution heat-treated pieces machined over the entire surface and ground on the revolving parts.
- Standard fitting of two PTFE bushes on the shutter stems to eliminate rotation friction.
- Seal rings compression-pressed from first grade elastomers. Standard silicone. On request EPDM, FTM, PTFE-coated FTM, PTFE + silicone.
- Interchangeability between the different standards available.
- Wide range of manual controls to meet different system requirements.
- Simple, safe and reliable operating.
- Horizontal and vertical single-effect, double-effect, and modulating pneumatic controls.
- Can be equipped with proximity contact, microswitch, solenoid valve, connector. Maximum operating pressure: 7 bars; 2 bars for PTFE gaskets.
- Standard production: 1"-10".



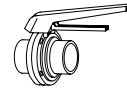

## VANNES PAPILLON

- Obtenues à partir de pièces moulées à chaud et thermotraitées.
- Obturateurs réalisés à l'aide d'éléments moulés à chaud et solubilisés, usinés mécaniquement sur toutes les surfaces et rectifiés sur les parties pivotantes.
- Application standard de 2 douilles en PTFE sur les arbres des obturateurs pour éliminer le frottement dans les rotations.
- Joints moulés sous pression et réalisés avec des élastomères de haute qualité. Standard silicone; sur demande, EPDM, FTM, FTM revêtu PTFE, PTFE + silicone.
- Interchangeabilité possible entre les différents standards.
- Vaste gamme de commandes manuelles pour répondre aux différentes exigences des installations.
- Simplicité, sécurité et fiabilité des manoeuvres.
- Commandes pneumatiques horizontales et verticales à simple effet, double effet et pour le réglage du flux; peuvent être munies de contact de proximité, minirupteur, électrovanne, connecteur.
- Pression d'exploitation maximum: 7 bars; pour joints en PTFE: 2 bars.
- Production standard: 1"-10".

## VÁLVULAS DE MARIPOSA

- Obtenidas a partir de piezas estampadas en caliente y solubilizadas.
- Obturadores obtenidos de piezas estampadas en caliente y solubilizadas, trabajadas mecánicamente en todas las superficies y rectificadas en las partes giratorias.
- Aplicación estándar de 2 camisas en PTFE en los ejes de los obturadores para eliminar el rozamiento en las rotaciones.
- Juntas producidas mediante estampado bajo compresión y con elastómeros de óptima calidad. Estándar silicona; a pedido, EPDM, FTM, FTM revestido PTFE, PTFE + silicona.
- Posibilidad de intercambio entre las distintas unificaciones.
- Amplia gama de mandos manuales para satisfacer las distintas exigencias de las instalaciones.
- Simplicidad, seguridad y fiabilidad de las maniobras.
- Mandos neumáticos horizontales y verticales de simple efecto, doble efecto y de regulación del flujo que se pueden equipar con microsensor, microinterruptor, electroválvula, conector.
- Máxima presión de ejercicio: 7 bares; para juntas en PTFE: 2 bares.
- Producción estándar: 1"-10".

V. FARFALLA EL.  
BUTTERFLY V. PE.  
V. PAPILLON BL.  
V. MARIPOSA EL.

### W100 BV

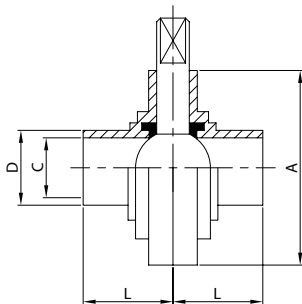

| DN     | A   | C     | D     | L     | gr   |        |
|--------|-----|-------|-------|-------|------|--------|
| 1"     | 25  | 79,0  | 22,1  | 25,4  | 34,0 | 725    |
| 1 1/2" | 38  | 85,0  | 34,8  | 38,1  | 38,0 | 805    |
| 2"     | 51  | 105,0 | 47,5  | 50,8  | 40,0 | 1.270  |
| 2 1/2" | 63  | 112,0 | 60,2  | 63,5  | 40,0 | 1.460  |
| 3"     | 76  | 125,0 | 72,9  | 76,2  | 41,0 | 1.755  |
| 4"     | 101 | 157,0 | 97,4  | 101,6 | 44,0 | 2.480  |
| 5"     | 127 | 180,0 | 122,0 | 127,0 | 40,0 | 4.100  |
| 6"     | 152 | 212,0 | 147,4 | 152,4 | 40,0 | 6.000  |
| 8"     | 203 | 256,5 | 198,2 | 203,2 | 45,0 | 7.800  |
| 10"    | 254 | 306,5 | 249,0 | 254,0 | 45,0 | 17.000 |

V. FARFALLA E. SM.  
BUTTERFLY V. E. FR.  
V. PAPILLON B. FR.  
V. MARIPOSA E. SM.

### K100 BV

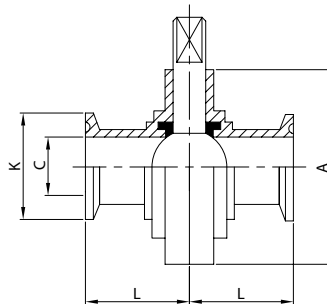

| DN     | A   | C     | K     | L     | gr   |        |
|--------|-----|-------|-------|-------|------|--------|
| 1"     | 25  | 79,0  | 22,1  | 50,5  | 35,0 | 950    |
| 1 1/2" | 38  | 85,0  | 34,8  | 50,5  | 36,0 | 995    |
| 2"     | 51  | 105,0 | 47,5  | 64,0  | 40,0 | 1.200  |
| 2 1/2" | 63  | 112,0 | 60,2  | 77,5  | 40,0 | 1.600  |
| 3"     | 76  | 125,0 | 72,9  | 91,0  | 40,0 | 1.950  |
| 4"     | 101 | 157,0 | 97,4  | 119,0 | 45,0 | 3.450  |
| 5"     | 127 | 180,0 | 122,0 | 144,5 | 41,0 | 4.300  |
| 6"     | 152 | 212,0 | 147,4 | 166,0 | 41,0 | 6.200  |
| 8"     | 203 | 256,5 | 198,2 | 217,0 | 45,0 | 8.100  |
| 10"    | 254 | 306,5 | 249,0 | 268,0 | 45,0 | 17.400 |

V. FARFALLA EL./E. SM.  
BUTTERFLY V. PE./E. FR.  
V. PAPILLON BL./B. FR.  
V. MARIPOSA EL./E. SM.

### WK100 BV

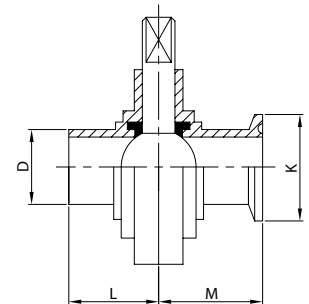

| DN     | D   | K     | L     | M    | gr   |        |
|--------|-----|-------|-------|------|------|--------|
| 1"     | 25  | 25,4  | 50,5  | 34,0 | 35,0 | 835    |
| 1 1/2" | 38  | 38,1  | 50,5  | 38,0 | 36,0 | 900    |
| 2"     | 51  | 50,8  | 64,0  | 40,0 | 40,0 | 1.235  |
| 2 1/2" | 63  | 63,5  | 77,5  | 40,0 | 40,0 | 1.530  |
| 3"     | 76  | 76,2  | 91,0  | 41,0 | 40,0 | 1.850  |
| 4"     | 101 | 101,6 | 119,0 | 44,0 | 45,0 | 3.145  |
| 5"     | 127 | 127,0 | 144,5 | 40,0 | 41,0 | 4.200  |
| 6"     | 152 | 152,4 | 166,0 | 40,0 | 41,0 | 6.100  |
| 8"     | 203 | 203,2 | 217,0 | 45,0 | 45,0 | 7.950  |
| 10"    | 254 | 254,0 | 268,0 | 45,0 | 45,0 | 17.200 |



VALVOLE A FARFALLA  
BUTTERFLY VALVES  
VANNES PAPILLON  
VÁLVULAS DE MARIPOSA

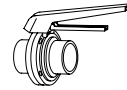

**CLAMP**

**MANIGLIA ESTRAIBILE**  
REMOVABLE HANDLE  
POIGNÉE AMOVIBLE  
MANETA EXTRAIBLE

**7M0**

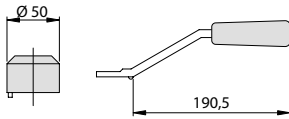

**MANIGLIA CON BLOCCAGGIO**  
HANDLE WITH BLOCKING  
POIGNÉE AVEC BLOCAJE  
MANETA CON BLOCAJE

**7M2**

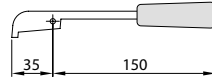

**MANIGLIA DI REG. 2 POS.**  
OPENING HANDLE 2 POS.  
POIGNÉE DE REGL. 2 POS.  
MANETA DE REGUL. 2 POS.

**7M3**

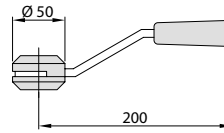

**MANIGLIA DI REG. 4 POS.**  
OPENING HANDLE 4 POS.  
POIGNÉE DE REGL. 4 POS.  
MANETA DE REGUL. 4 POS.

**7M12**

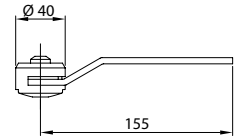

**MANIGLIA DI REG. 7 POS.**  
OPENING HANDLE 7 POS.  
POIGNÉE DE REGL. 7 POS.  
MANETA DE REGUL. 7 POS.

**7M9**

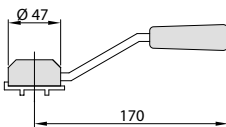

**MANIGLIA DI REG. 10 POS.**  
OPENING HANDLE 10 POS.  
POIGNÉE DE REGL. 10 POS.  
MANETA DE REGUL. 10 POS.

**7M4**

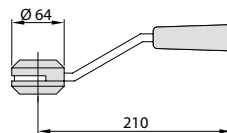

**MANIGLIA DI REG. 20 POS.**  
OPENING HANDLE 20 POS.  
POIGNÉE DE REGL. 20 POS.  
MANETA DE REGUL. 20 POS.

**7M5**

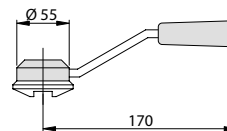

**TESTA DI REG. MICROMET.**  
MICROMETRIC HANDLE  
TÊTE RÉGL. MICROMÉTR.  
CABEZAL DE REG. MICROM.

**7M6**

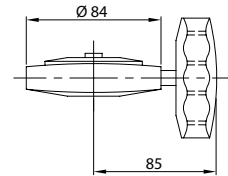

**MANIGLIA ABS CON LEVA**  
ABS HANDLE WITH LEVER  
POIGNÉE ABS AVEC LEVIER  
MANETA A GATILLO ABS

**7M8**

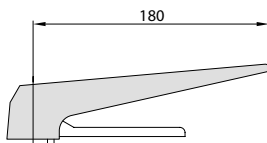

**MAN. CON LEVA 7 POS.**  
H. WITH LEVER 7 POS.  
P. AVEC LEVIER 7 POS.  
MAN. A GATILLO 7 POS.

**7M11**

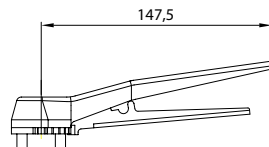

**GUARNIZIONE VALVOLA FARFALLA**  
BUTTERFLY VALVE SEAL RING  
JOINT VANNE PAPILLON  
JUNTA VÁLVULA MARIPOSA

**700 02**

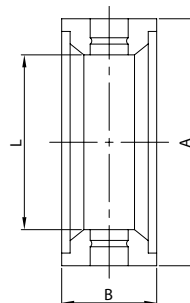

| DIAM.   | A     | B    | L     |
|---------|-------|------|-------|
| 25/28   | 43,6  | 23,2 | 27,0  |
| 34/38   | 52,3  | 23,2 | 35,0  |
| 40      | 55,6  | 23,2 | 39,0  |
| 51/52   | 66,0  | 23,2 | 49,0  |
| 60/63   | 76,4  | 23,4 | 59,5  |
| 70/76   | 88,8  | 25,4 | 69,5  |
| 85      | 99,0  | 25,4 | 79,5  |
| 101/104 | 119,0 | 25,4 | 100,0 |





VALVOLE A FARFALLA  
BUTTERFLY VALVES  
VANNES PAPILLON  
VÁLVULAS DE MARIPOSA

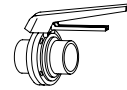

**CLAMP**

CILINDRO PNEUM. DE.  
PNEUM. ACTUATOR DE.  
VÉRIN PNEUM. DE.  
CILINDRO NEUM. DE.

**7C1 L**

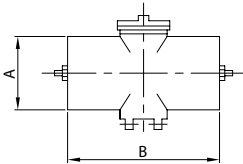

| DN      | A    | B     | gr    |
|---------|------|-------|-------|
| 25/52   | 60,0 | 138,5 | 1.460 |
| 63/85   | 76,0 | 161,0 | 2.100 |
| 101/104 | 89,0 | 180,0 | 2.960 |

CILINDRO PNEUM. SE.  
PNEUM. ACTUATOR SE.  
VÉRIN PNEUM. SE.  
CILINDRO NEUM. SE.

**7C2 L**

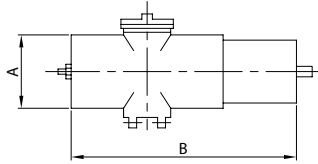

| DN    | A    | B     | gr    |
|-------|------|-------|-------|
| 25/52 | 76,0 | 240,0 | 2.190 |
| 63/85 | 89,0 | 260,0 | 3.150 |

C. PNEUM. REGOL. FLUSSO  
RÉGUL. FLUX PNEUM. ACT.  
VÉ. PNEUM. RÉGULATION  
CIL. NEUM. REGULACIÓN

**7C1 L M**

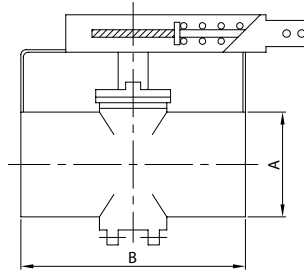

| DN     | A    | B     | gr    |
|--------|------|-------|-------|
| 25/104 | 89,0 | 180,0 | 4.160 |

C. PNEUM. SE. VERTICALE  
PNEUM. ACT. SE. VERTICAL  
VÉ. PNEUM. SE. VERTICALE  
CIL. NEUM. SE. VERTICAL

**7C4 L**

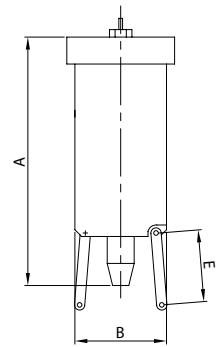

| DN     | A     | B    | E    | gr    |
|--------|-------|------|------|-------|
| 25/52  | 211,0 | 76,0 | 64,0 | 3.700 |
| 63/104 | 211,0 | 76,0 | 58,0 | 3.700 |

C. PN. UNITÀ CONTR.  
CONTR. UNIT PN. ACT.  
VÉ. PN. UNITÉ CONTR.  
CIL. N. UNIDAD CONTR.

**7C4 UC**

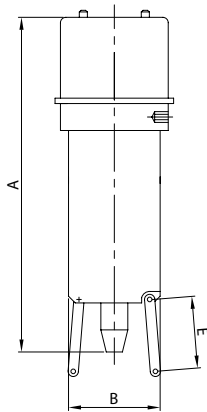

| DN     | A     | B    | E    | gr    |
|--------|-------|------|------|-------|
| 25/52  | 316,0 | 76,0 | 64,0 | 3.900 |
| 63/104 | 316,0 | 76,0 | 58,0 | 3.900 |

C. PN. DE. VERTICALE  
PN. ACT. DE. VERTICAL  
VÉ. PN. DE. VERTICALE  
CIL. N. DE. VERTICAL

**7C5 L**

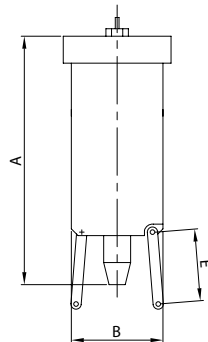

| DN     | A     | B    | E    | gr    |
|--------|-------|------|------|-------|
| 25/52  | 211,0 | 76,0 | 64,0 | 3.700 |
| 63/104 | 211,0 | 76,0 | 58,0 | 3.700 |

ELETTOVALVOLA NC.  
SOLENOID VALVE NC.  
ÉLECTROVANNE NF.  
ELECTROVÁLVULA NC.

**015 NC**

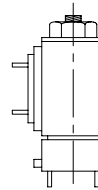

ELETTOVALVOLA NA.  
SOLENOID VALVE NO.  
ÉLECTROVANNE NO.  
ELECTROVÁLVULA NA.

**015 NA**

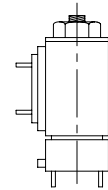

MICROINTERRUTTORE  
MICROSWITCH  
MINIRUPTEUR  
MICROINTERRUPTOR

**014 1**

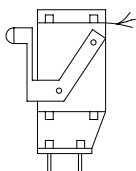

CONTATTO DI PROSSIMITÀ  
PROXIMITY CONTACT  
CONTACT DE PROXIMITÉ  
MICROSENSOR

**013 0**

**013 S**

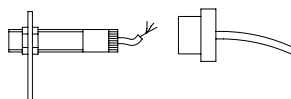

CONNETTORE  
CONNECTOR  
CONNECTEUR  
CONECTOR

**030 H**

**030 S**

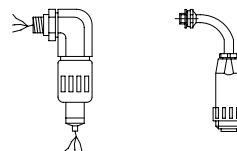

CAPPELOTTO  
CAP  
CAPOT  
CAPUCHÓN

**700 4 13**

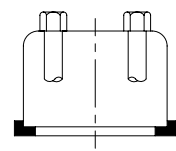

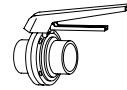

## VALVOLE A FARFALLA A CERNIERA

- Ricavate da particolari stampati a caldo e solubilizzati.
- Otturatori ricavati da particolari in acciaio inossidabile AISI 316L stampati a caldo e solubilizzati, lavorati meccanicamente su tutte le superfici e rettificati sulle parti rotanti.
- Facilità di accesso durante le operazioni di pulizia.
- Applicazione standard di 2 bussole in PTFE sugli alberi degli otturatori per eliminare l'attrito nelle rotazioni.
- Guarnizioni prodotte con stampaggio a compressione e con elastomeri di ottima qualità. Standard silicone; a richiesta, EPDM, viton, viton rivestito PTFE, PTFE + silicone.
- Possibilità di intercambiabilità tra le varie unificazioni.
- Semplicità, sicurezza e affidabilità delle manovre.
- Max. pressione di esercizio: 2 bar.
- Produzione standard: 2".

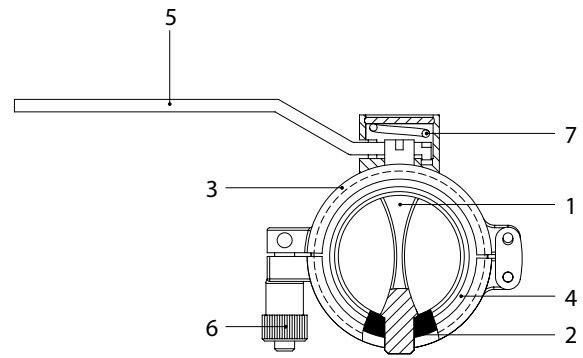

- |   |   |   |
|---|---|---|
| 1. Otturatore<br>Butterfly<br>Papillon<br>Obturador | 4. Flangia<br>Flange<br>Bride<br>Brida        | 7. Molla<br>Spring<br>Ressort<br>Muelle |
| 2. Guarnizione<br>Gasket<br>Joint<br>Junta          | 5. Maniglia<br>Handle<br>Poignée<br>Maneta    |   |
| 3. Morsetto<br>Clamp<br>Collier<br>Abrazadera       | 6. Ghiera<br>Locking ring<br>Embout<br>Tuerca |   |

## HINGED BUTTERFLY VALVES

- Made from press-forged and solution heat-treated blanks.
- Shutters made from press-forged and solution heat-treated AISI 316L stainless steel pieces machined over the entire surface and ground on the revolving parts.
- Easy access for cleaning.
- Standard fitting of two PTFE bushes on the shutter stems to eliminate rotation friction.
- Seal rings compression-pressed from first grade elastomers. Standard silicone. On request EPDM, viton, PTFE-coated viton, PTFE + silicone.
- Interchangeability between the different standards available.
- Simple, safe and reliable operating.
- Maximum operating pressure: 2 bars.
- Standard production: 2".



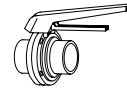

## VANNES PAPILLON À CHARNIÈRE

- Obtenues à partir de pièces moulées à chaud et solubilisées.
- Obturateurs réalisés à l'aide d'éléments en acier inoxydable AISI 316L moulés à chaud et solubilisés, usinés mécaniquement sur toutes les surfaces et rectifiés sur les parties pivotantes.
- Simplicité d'accès durant les opérations d'entretien.
- Application standard de 2 douilles en PTFE sur les arbres des obturateurs pour éliminer le frottement dans les rotations.
- Joints moulés sous pression et réalisés avec des élastomères de haute qualité. Standard silicone; sur demande, EPDM, viton, viton revêtu PTFE, PTFE + silicone.
- Interchangeabilité possible entre les différents standards.
- Simplicité, sécurité et fiabilité des manoeuvres.
- Pression de service maximale: 2 bars.
- Production standard: 2".

## VÁLVULAS DE MARIPOSA DE CREMALLERA

- Obtenidas a partir de piezas de acero inoxidable AISI 316L estampadas en caliente y solubilizadas.
- Obturadores obtenidos de piezas estampadas en caliente y solubilizadas, trabajadas mecánicamente en todas las superficies y rectificadas en las partes giratorias.
- Facilidad de acceso durante las operaciones de limpieza.
- Aplicación estándar de 2 camisas en PTFE en los ejes de los obturadores para eliminar el rozamiento en las rotaciones.
- Juntas producidas mediante estampado bajo compresión y con elastómeros de óptima calidad. Estándar silicona; a pedido, EPDM, viton, viton revestido PTFE, PTFE + silicona.
- Posibilidad de intercambio entre las distintas unificaciones.
- Simplicidad, seguridad y fiabilidad de las maniobras.
- Máxima presión de ejercicio: 2 bares.
- Producción estándar: 2".

V. F. CERNIERA. EL.  
HINGED B. V. PE.  
V. P. CHARNIÈRE BL.  
V. M. CREMALLERA EL.

### W110 BV

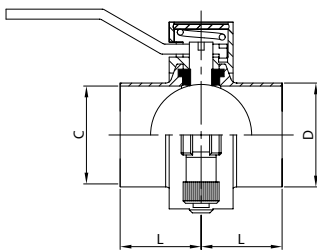

| DN    | C    | D    | L    | gr  |
|-------|------|------|------|-----|
| 2" 51 | 47,5 | 58,0 | 40,0 | 850 |

V. F. CERNIERA E. SM.  
HINGED B. V. E. FR.  
V. P. CHARNIÈRE B. FR.  
V. M. CREMALLERA E. SM.

### K110 BV

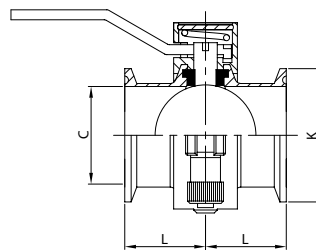

| DN    | C    | K    | L    | gr  |
|-------|------|------|------|-----|
| 2" 51 | 47,5 | 64,0 | 40,0 | 880 |

V. F. CERN. EL./E. SM.  
HINGED B. V. PE./E. FR.  
V. PAP. CH. BL./B. FR.  
V. M. CREM. EL./E. SM.

### WK110 BV

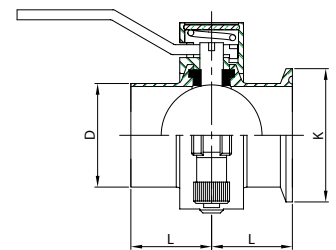

| DN    | D    | K    | L    | gr  |
|-------|------|------|------|-----|
| 2" 51 | 50,8 | 64,0 | 40,0 | 865 |



## VALVOLE A SFERA

- Di solida e robusta costruzione.
- Facilmente sterilizzabili. Elementi interni facilmente raggiungibili durante le fasi di lavaggio CIP nei modelli 50 e 51.
- Facilmente disassemblabili. Disassemblaggio in linea nei modelli 90 e 91.
- Modello 90 realizzato seguendo rigorosamente i criteri e i test imposti dalle norme 3-A.
- Guarnizione sanitaria nel modello 90.
- Corredabili di comandi manuali o pneumatici.
- Comandi pneumatici orizzontali e verticali a semplice effetto, doppio effetto e di regolazione flusso, corredabili di contatto di prossimità, microinterruttore, elettrovalvola, connettore.
- Max. pressione di esercizio: 10 bar.

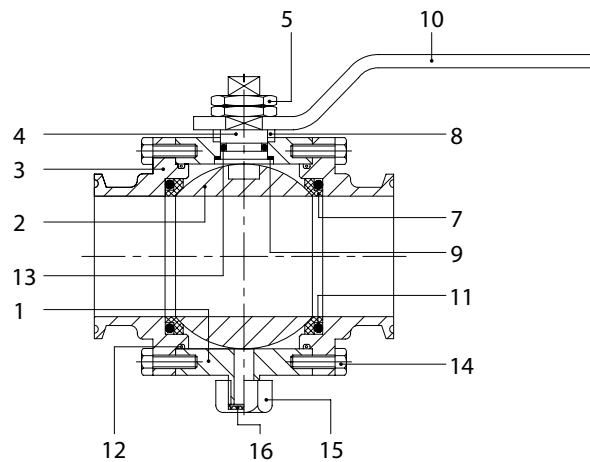

51

|   |  |   |
|---|--|---|
| 1. Corpo valvola<br>Valve body<br>Corps vanne<br>Cuerpo                   | 7. Guarnizione<br>Gasket<br>Joint<br>Junta                           | 12. Anello di tenuta OR<br>OR seal ring<br>Joint torique<br>Junta OR          |
| 2. Sfera<br>Ball<br>Boule<br>Bola   | 8. Distanziale<br>Spacer<br>Entretoise<br>Distanciador               | 13. Anello di tenuta OR<br>OR seal ring<br>Joint torique<br>Junta OR          |
| 3. Flangia<br>Flange<br>Bride<br>Brida                                    | 9. Rondella<br>Washer<br>Rondelle<br>Arandela                        | 14. Vite esagonale<br>Hexagonal screw<br>Vis hexagonale<br>Tornillo hexagonal |
| 4. Perno<br>Spindle<br>Pivot<br>Perno                                     | 10. Maniglia<br>Handle<br>Poignée<br>Maneta                          | 15. Dado esagonale<br>Hexagonal nut<br>Écrou hexagonal<br>Tuerca hexagonal    |
| 5. Dado esagonale<br>Hexagonal nut<br>Écrou hexagonal<br>Tuerca hexagonal | 11. Anello di tenuta OR<br>OR seal ring<br>Joint torique<br>Junta OR | 16. Pastiglia PTFE<br>PTFE pin<br>Pastille PTFE<br>Pastilla PTFE              |

## BALL VALVES

- Heavy duty construction.
- Easy to sterilize. Internal parts easy to reach during CIP process in models 50 and 51.
- Easy to disassemble. On-line disassembly in models 90 and 91.
- Model 90 produced in strict conformity with criteria and tests required by 3-A standards.
- Sanitary gasket in model 90.
- Can be equipped with manual or pneumatic controls.
- Horizontal and vertical single-effect, double-effect, and modulating pneumatic controls. Can be equipped with proximity contact, microswitch, solenoid valve, connector.
- Maximum operating pressure: 10 bars.





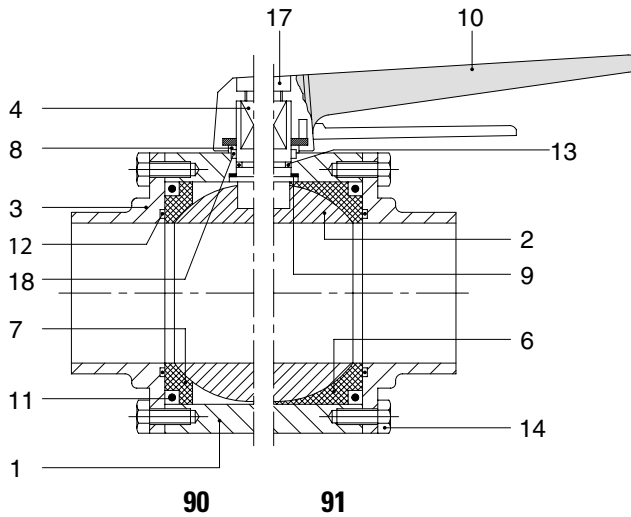

|   |  |   |
|---|--|---|
| 1. Corpo valvola<br>Valve body<br>Corps vanne<br>Cuerpo                           | 7. Guarnizione<br>Gasket<br>Joint<br>Junta                           | 12. Anello di tenuta OR<br>OR seal ring<br>Joint torique<br>Junta OR          |
| 2. Sfera<br>Ball<br>Boule<br>Bola   | 8. Distanziale<br>Spacer<br>Entretoise<br>Distanciador               | 13. Anello di tenuta OR<br>OR seal ring<br>Joint torique<br>Junta OR          |
| 3. Flangia<br>Flange<br>Bride<br>Brida  | 9. Rondella<br>Washer<br>Rondelle<br>Arandela                        | 14. Vite esagonale<br>Hexagonal screw<br>Vis hexagonale<br>Tornillo hexagonal |
| 4. Perno<br>Spindle<br>Pivot<br>Perno   | 10. Maniglia<br>Handle<br>Poignée<br>Maneta                          | 17. Vite brugola<br>Allen screw<br>Vis Allen<br>Tornillo Allen                |
| 6. Guarnizione sanitaria<br>Sanitary gasket<br>Joint sanitaire<br>Junta sanitaria | 11. Anello di tenuta OR<br>OR seal ring<br>Joint torique<br>Junta OR | 18. Rondella<br>Washer<br>Rondelle<br>Arandela                                |



## VANNES À BOULE

- Fabrication solide et robuste.
- Facilement stérilisables. Éléments internes faciles à atteindre durant les opérations de lavage CIP pour les modèles 50 et 51.
- Facilement démontables. Démontage en ligne pour les modèles 90 et 91.
- Modèle 90 réalisé en respectant scrupuleusement les critères et les tests imposés par les normes 3-A.
- Joint sanitaire pour le modèle 90.
- Peuvent être munis de commandes manuelles ou pneumatiques.
- Commandes pneumatiques horizontales et verticales à simple effet, double effet et pour le réglage du flux; peuvent être munies de contact de proximité, minirupteur, électrovanne, connecteur.
- Pression d'exploitation maximum: 10 bars.

## VÁLVULAS DE BOLA

- Fabricación sólida y robusta.
- Fácilmente esterilizables. Los elementos internos son fácilmente accesibles durante las fases de lavado CIP en los modelos 50 y 51.
- Se pueden desmontar fácilmente. Desmontaje en línea en los modelos 90 y 91.
- Modelo 90 realizado respetando rigurosamente los criterios y los tests establecidos por las normas 3-A.
- Junta sanitaria en el modelo 90.
- Equipadas con mandos manuales o neumáticos.
- Mandos neumáticos horizontales y verticales de simple efecto, doble efecto y de regulación del flujo que se pueden equipar con microsensor, microinterruptor, electroválvula, conector.
- Máxima presión de ejercicio: 10 bares.



VALVOLE A SFERA  
BALL VALVES  
VANNES À BOULE  
VÁLVULAS DE BOLA



**CLAMP**

V. SFERA SAN. DREN. EL.  
SAN. DRAIN. BALL V. PE.  
V. BOULE SAN. DRAIN. BL.  
V. BOLA SAN. DREN. EL.

**W50**

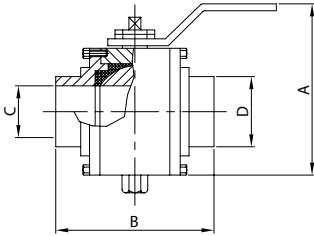

| DN     | A   | B     | C     | D    | gr    |        |
|--------|-----|-------|-------|------|-------|--------|
| 1"     | 25  | 90,0  | 95,0  | 22,1 | 25,4  | 1.100  |
| 1 1/2" | 38  | 110,0 | 107,0 | 34,8 | 38,1  | 2.090  |
| 2"     | 51  | 126,0 | 118,0 | 47,5 | 50,8  | 3.140  |
| 2 1/2" | 63  | 143,0 | 135,0 | 60,2 | 63,5  | 4.730  |
| 3"     | 76  | 163,0 | 158,0 | 72,0 | 76,2  | 6.940  |
| 4"     | 101 | 202,0 | 170,0 | 97,4 | 101,6 | 13.570 |

V. SFERA SAN. DR. E. SM.  
SAN. DR. BALL V. E. FR.  
V. BOULE SAN. DR. B. FR.  
V. BOLA SAN. DR. E. SM.

**K50**

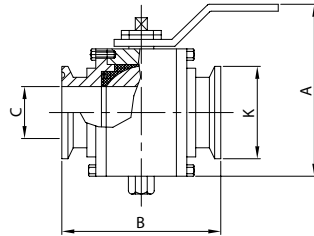

| DN     | A   | B     | C     | K    | gr    |        |
|--------|-----|-------|-------|------|-------|--------|
| 1"     | 25  | 90,0  | 95,0  | 22,1 | 50,5  | 1.120  |
| 1 1/2" | 38  | 110,0 | 107,0 | 34,8 | 50,5  | 2.120  |
| 2"     | 51  | 126,0 | 118,0 | 47,5 | 64,0  | 3.190  |
| 2 1/2" | 63  | 143,0 | 135,0 | 60,2 | 77,5  | 4.790  |
| 3"     | 76  | 163,0 | 158,0 | 72,0 | 91,0  | 7.010  |
| 4"     | 101 | 202,0 | 170,0 | 97,4 | 119,0 | 13.670 |

V. SFERA DRENAGGIO EL.  
DRAINAGE BALL V. PE.  
V. BOULE DRAINAGE BL.  
V. BOLA DRENAJE EL.

**W51**

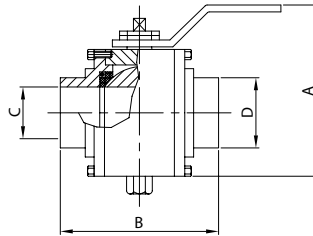

| DN     | A   | B     | C     | D    | gr    |        |
|--------|-----|-------|-------|------|-------|--------|
| 1"     | 25  | 90,0  | 95,0  | 22,1 | 25,4  | 1.090  |
| 1 1/2" | 38  | 110,0 | 107,0 | 34,8 | 38,1  | 2.080  |
| 2"     | 51  | 126,0 | 118,0 | 47,5 | 50,8  | 3.120  |
| 2 1/2" | 63  | 143,0 | 135,0 | 60,2 | 63,5  | 4.710  |
| 3"     | 76  | 163,0 | 158,0 | 72,0 | 76,2  | 6.910  |
| 4"     | 101 | 202,0 | 170,0 | 97,4 | 101,6 | 13.530 |

V. SFERA DRENAG. E. SM.  
DRAINAGE BALL V. E. FR.  
V. BOULE DRAINAGE B. FR.  
V. BOLA DRENAJE E. SM.

**K51**

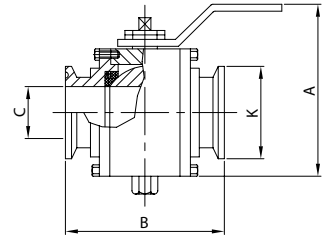

| DN     | A   | B     | C     | K    | gr    |        |
|--------|-----|-------|-------|------|-------|--------|
| 1"     | 25  | 90,0  | 95,0  | 22,1 | 50,5  | 1.110  |
| 1 1/2" | 38  | 110,0 | 107,0 | 34,8 | 50,5  | 2.110  |
| 2"     | 51  | 126,0 | 118,0 | 47,5 | 64,0  | 3.170  |
| 2 1/2" | 63  | 143,0 | 135,0 | 60,2 | 77,5  | 4.770  |
| 3"     | 76  | 163,0 | 158,0 | 72,0 | 91,0  | 6.980  |
| 4"     | 101 | 202,0 | 170,0 | 97,4 | 119,0 | 13.630 |

V. SFERA ESTR. SAN. EL.  
SAN. EXTR. BALL V. PE.  
V. BOULE EXTR. SAN. BL.  
V. BOLA EXTR. SAN. EL.

**W90**

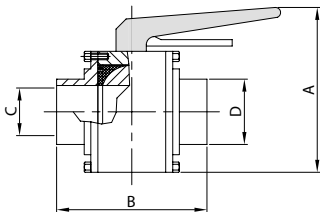

| DN     | A  | B     | C     | D    | gr   |       |
|--------|----|-------|-------|------|------|-------|
| 1/2"   | 12 | 100,0 | 74,5  | 9,4  | 12,7 | 760   |
| 3/4"   | 19 | 100,0 | 74,5  | 15,7 | 19,0 | 760   |
| 1"     | 25 | 110,0 | 96,0  | 22,1 | 25,4 | 1.130 |
| 1 1/2" | 38 | 130,0 | 109,0 | 34,8 | 38,1 | 2.070 |
| 2"     | 51 | 145,0 | 124,0 | 47,5 | 50,8 | 2.800 |
| 2 1/2" | 63 | 168,0 | 135,0 | 60,2 | 63,5 | 4.840 |
| 3"     | 76 | 182,0 | 158,0 | 72,0 | 76,2 | 7.480 |

V. SFERA ESTR. S. E. SM.  
SAN. EXTR. BALL V. E. FR.  
V. BOULE EXTR. S. B. FR.  
V. BOLA EXTR. SAN. E. SM.

**K90**

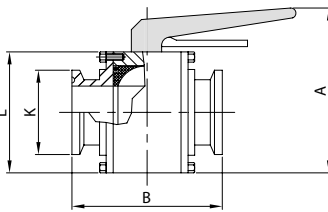

| DN     | A  | B     | L     | K     | gr   |       |
|--------|----|-------|-------|-------|------|-------|
| 1/2"   | 12 | 100,0 | 80,5  | 55,0  | 25,0 | 780   |
| 3/4"   | 19 | 100,0 | 80,5  | 55,0  | 25,0 | 780   |
| 1"     | 25 | 110,0 | 96,0  | 60,0  | 50,5 | 1.150 |
| 1 1/2" | 38 | 130,0 | 109,0 | 80,0  | 50,5 | 2.100 |
| 2"     | 51 | 145,0 | 124,0 | 95,0  | 64,0 | 2.850 |
| 2 1/2" | 63 | 168,0 | 135,0 | 118,0 | 77,5 | 4.900 |
| 3"     | 76 | 182,0 | 158,0 | 132,0 | 91,0 | 7.550 |

V. SFERA ESTRAIB. EL.  
EXTRACT. BALL V. PE.  
V. BOULE EXTRACT. BL.  
V. BOLA EXTR. EL.

**W91**

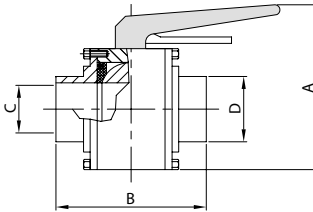

| DN     | A  | B     | C     | D    | gr   |       |
|--------|----|-------|-------|------|------|-------|
| 1/2"   | 12 | 100,0 | 74,5  | 9,4  | 12,7 | 750   |
| 3/4"   | 19 | 100,0 | 74,5  | 15,7 | 19,0 | 750   |
| 1"     | 25 | 110,0 | 96,0  | 22,1 | 25,4 | 1.120 |
| 1 1/2" | 38 | 130,0 | 109,0 | 34,8 | 38,1 | 2.060 |
| 2"     | 51 | 145,0 | 124,0 | 47,5 | 50,8 | 2.780 |
| 2 1/2" | 63 | 168,0 | 135,0 | 60,2 | 63,5 | 4.820 |
| 3"     | 76 | 182,0 | 158,0 | 72,0 | 76,2 | 7.450 |

V. SFERA ESTRAIB. E. SM.  
EXTRACT. BALL. V. E. FR.  
V. BOULE EXTRACT. B. FR.  
V. BOLA EXTR. E. SM.

**K91**

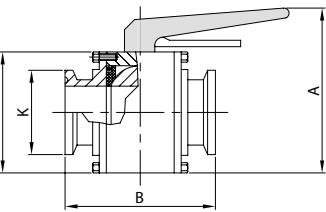

| DN     | A  | B     | L     | K     | gr   |       |
|--------|----|-------|-------|-------|------|-------|
| 1/2"   | 12 | 100,0 | 80,5  | 55,0  | 25,0 | 770   |
| 3/4"   | 19 | 100,0 | 80,5  | 55,0  | 25,0 | 770   |
| 1"     | 25 | 110,0 | 96,0  | 60,0  | 50,5 | 1.140 |
| 1 1/2" | 38 | 130,0 | 109,0 | 80,0  | 50,5 | 2.090 |
| 2"     | 51 | 145,0 | 124,0 | 95,0  | 64,0 | 2.830 |
| 2 1/2" | 63 | 168,0 | 135,0 | 118,0 | 77,5 | 4.880 |
| 3"     | 76 | 182,0 | 158,0 | 132,0 | 91,0 | 7.520 |



CILINDRO PNEUM. DE.  
PNEUM. ACTUATOR DE.  
VÉRIN PNEUM. DE.  
CILINDRO NEUM. DE.

**7C1 L**

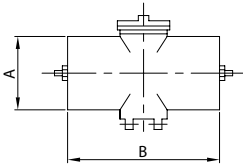

| DN      | A    | B     | gr    |
|---------|------|-------|-------|
| 25/52   | 60,0 | 138,5 | 1.460 |
| 63/85   | 76,0 | 161,0 | 2.100 |
| 101/104 | 89,0 | 180,0 | 2.960 |

CILINDRO PNEUM. SE.  
PNEUM. ACTUATOR SE.  
VÉRIN PNEUM. SE.  
CILINDRO NEUM. SE.

**7C2 L**

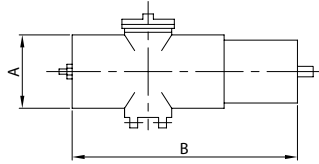

| DN    | A    | B     | gr    |
|-------|------|-------|-------|
| 25/52 | 76,0 | 240,0 | 2.190 |
| 63/85 | 89,0 | 260,0 | 3.150 |

C. PNEUM. REGOL. FLUSSO  
RÉGUL. FLUX PNEUM. ACT.  
VÉ. PNEUM. RÉGULATION  
CIL. NEUM. REGULACIÓN

**7C1 L M**

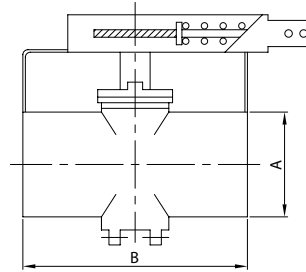

| DN     | A    | B     | gr    |
|--------|------|-------|-------|
| 25/104 | 89,0 | 180,0 | 4.160 |

C. PNEUM. SE. VERTICALE  
PNEUM. ACT. SE. VERTICAL  
VÉ. PNEUM. SE. VERTICALE  
CIL. NEUM. SE. VERTICAL

**7C4 L**

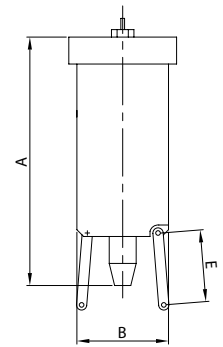

| DN     | A     | B    | E    | gr    |
|--------|-------|------|------|-------|
| 25/52  | 211,0 | 76,0 | 64,0 | 3.700 |
| 63/104 | 211,0 | 76,0 | 58,0 | 3.700 |

C. PN. UNITÀ CONTR.  
CONTR. UNIT PN. ACT.  
VÉ. PN. UNITÉ CONTR.  
CIL. N. UNIDAD CONTR.

**7C4 UC**

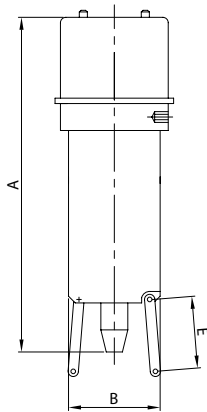

| DN     | A     | B    | E    | gr    |
|--------|-------|------|------|-------|
| 25/52  | 316,0 | 76,0 | 64,0 | 3.900 |
| 63/104 | 316,0 | 76,0 | 58,0 | 3.900 |

C. PN. DE. VERTICALE  
PN. ACT. DE. VERTICAL  
VÉ. PN. DE. VERTICALE  
CIL. N. DE. VERTICAL

**7C5 L**

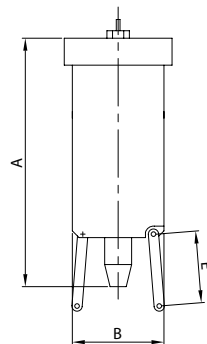

| DN     | A     | B    | E    | gr    |
|--------|-------|------|------|-------|
| 25/52  | 211,0 | 76,0 | 64,0 | 3.700 |
| 63/104 | 211,0 | 76,0 | 58,0 | 3.700 |

ELETTOVALVOLA NC.  
SOLENOID VALVE NC.  
ÉLECTROVANNE NF.  
ELECTROVÁLVULA NC.

**015 NC**

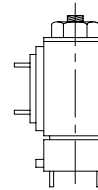

ELETTOVALVOLA NA.  
SOLENOID VALVE NO.  
ÉLECTROVANNE NO.  
ELECTROVÁLVULA NA.

**015 NA**

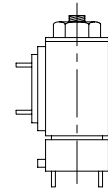

MICROINTERRUTTORE  
MICROSWITCH  
MINIRUPTEUR  
MICROINTERRUPTOR

**014 1**

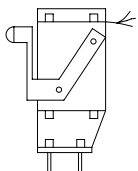

CONTATTO DI PROSSIMITÀ  
PROXIMITY CONTACT  
CONTACT DE PROXIMITÉ  
MICROSENSOR

**013 0**

**013 S**

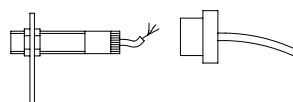

CONNETTORE  
CONNECTOR  
CONNECTEUR  
CONECTOR

**030 H**

**030 S**

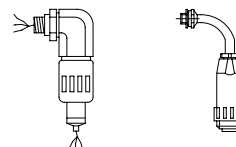

CAPPELOTTO  
CAP  
CAPOT  
CAPUCHÓN

**700 4 13**

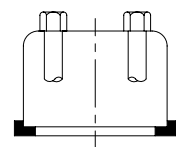



## VALVOLE PNEUMATICHE NORME 3-A

- Realizzate seguendo rigorosamente i criteri e i test imposti dalle norme 3-A.
- Completo autodrenaggio della valvola garantito dalla forma sferica interna e dalla lucidatura delle parti interne.
- Elementi di tenuta facilmente raggiungibili durante le fasi di lavaggio CIP.
- Facilità di manutenzione consentita dall'assemblaggio della valvola mediante un morsetto Clamp a 3 ganasce.
- Entrata aria nella testata superiore della valvola e distribuzione nella parte inferiore tramite il pistone interno.
- Assoluta sicurezza durante le operazioni di montaggio e smontaggio garantita da uno speciale dispositivo per il costante contenimento in compressione delle molle.
- Presenza di una speciale bussola a garanzia della perfetta coassialità del cilindro rispetto al corpo valvola, per la facilitazione dello scorrimento delle parti in movimento, la completa tenuta del prodotto e la totale igienicità durante le fasi di lavaggio CIP, consentite anche dalla presenza di un anello di tenuta OR nella parte finale.
- Facilmente sterilizzabili.
- Comandi pneumatici a doppio effetto o semplice effetto, corredabili di contatto di prossimità, microinterruttore, elettrovalvola, connettore.



### **3-A APPROVED PNEUMATIC VALVES**

- Produced in strict conformity with criteria and tests required by 3-A standards.
- Full self-drainage of valve due to spherical internal shape and polishing of internal parts.
- Seal members easy to access during CIP process.
- Easy maintenance due to assembly of valve using 3-piece clamp.
- Air entry into the upper head of the valve and distribution in the lower part by an internal piston.
- Absolute safety during assembly and disassembly ensured by a special device to keep the springs under constant compression.
- Special bushing to ensure perfect coaxiality of cylinder and valve body, to facilitate moving parts, full product sealing and total hygiene during CIP process thanks also to the OR seal ring in terminal part.
- Easy to sterilize.
- Double-effect and single-effect pneumatic controls; can be equipped with proximity contact, microswitch, solenoid valve, connector.

### **VANNES PNEUMATIQUES NORMES 3-A**

- Réalisées en respectant scrupuleusement les critères et les tests imposés par les normes 3-A.
- Autodrainage complet de la vanne garanti par la forme interne sphérique et le polissage des parties internes.
- Éléments d'étanchéité faciles à atteindre durant les opérations de lavage CIP.
- Entretien facile grâce à l'assemblage de la vanne avec un collier Clamp 3 pièces.
- Admission de l'air par la partie supérieure de la vanne et refoulement dans la partie inférieure à l'aide du piston interne.
- Sécurité absolue au cours des opérations de montage et démontage grâce à un dispositif spécial assurant le maintien constant sous compression des ressorts.
- Présence d'une douille spéciale garantissent la parfaite coaxialité du cylindre par rapport au corps de la vanne, facilitant le glissement des pièces en mouvement, assurant l'étanchéité totale du produit et une hygiène complète lors des opération de lavage CIP. Ces propriétés sont rendues possibles aussi par la présence d'un joint torique dans la partie finale.
- Facilement stérilisables.
- Commandes pneumatiques à double effet ou simple effet; peuvent être munies de contact de proximité, minirupteur, électrovanne, connecteur.

### **VÁLVULAS NEUMÁTICAS NORMAS 3-A**

- Realizadas respetando rigurosamente los criterios y los tests establecidos por las normas 3-A.
- Completo autodrenaje de la válvula garantizado por la forma interior esférica y por el pulido de las partes interiores.
- Elementos de cierre a los que se puede llegar fácilmente durante el proceso de lavado CIP.
- Facilidad de mantenimiento gracias al ensamblado de la válvula mediante una abrazadera de 3 mordazas.
- Entrada de aire en la cabeza superior de la válvula y distribución en la parte inferior mediante el pistón interno.
- Absoluta seguridad durante las operaciones de montaje y desmontaje, garantizada por un dispositivo especial que permite mantener constantemente bajo compresión los muelles.
- Presencia de un casquillo especial para garantizar la perfecta coaxialidad del cilindro con respecto al cuerpo de la válvula, para facilitar el desplazamiento de las partes en movimiento, el cierre perfecto del producto y la más completa higiene durante las fases de lavado CIP, gracias también a la presencia de una junta OR en la parte final.
- Fácilmente esterilizables.
- Mandos neumáticos de doble efecto o de simple efecto que se pueden equipar con microsensor, microinterruptor, electroválvula, conector.



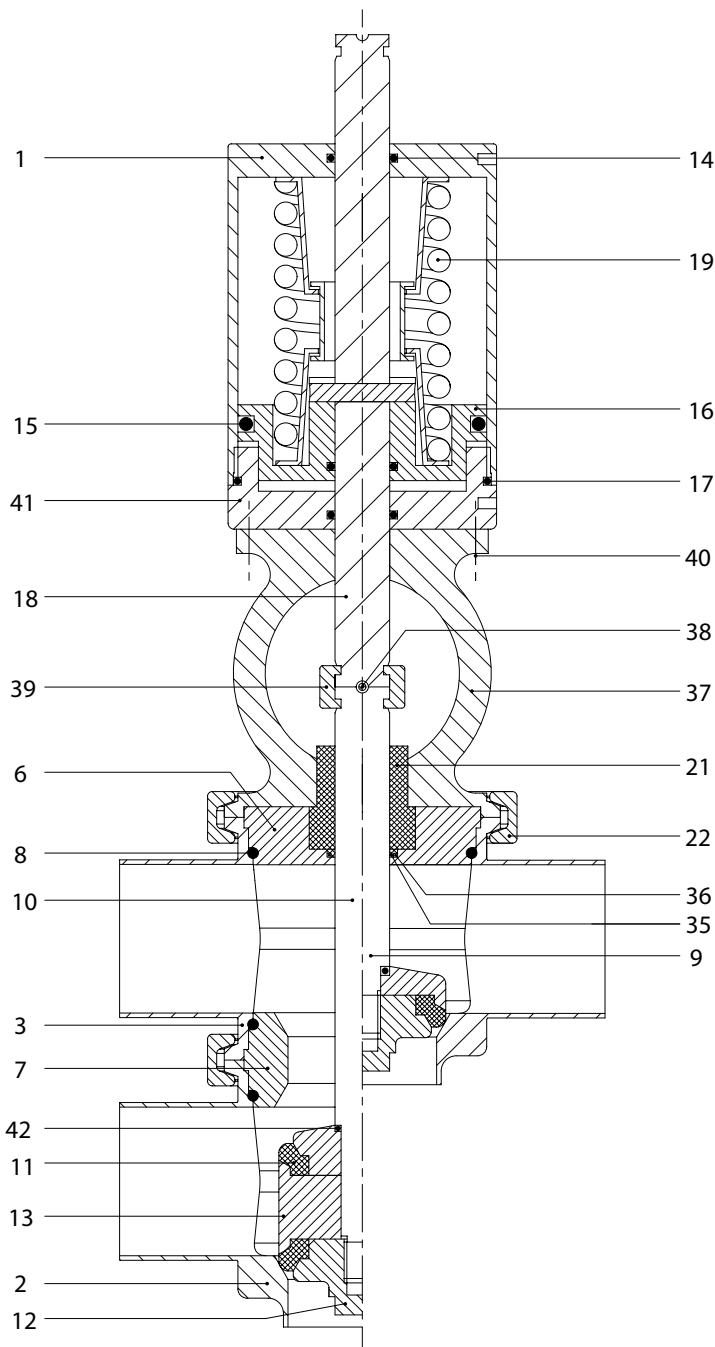

- |  |  |
|--|--|
| 1. Cilindro<br>Cylinder<br>Cylindre<br>Cilindro  | 17. Anello di tenuta OR<br>OR seal ring<br>Joint torique<br>Junta OR             |
| 2. Corpo valvola<br>Valve body<br>Corps vanne<br>Cuerpo válvula  | 18. Albero<br>Shaft<br>Arbre<br>Eje  |
| 3. Corpo intermedio<br>Middle body<br>Corps intermédiaire<br>Cuerpo intermedio                           | 19. Molla<br>Spring<br>Ressort<br>Muelle   |
| 6. Testata superiore<br>Top head<br>Tête supérieure<br>Cabezal superior                                  | 21. Bussola PTFE<br>PTFE bush<br>Douille PTFE<br>Casquillo PTFE                  |
| 7. Testata inferiore<br>Bottom head<br>Tête inférieure<br>Cabezal inferior                               | 22. Morsetto Clamp<br>Clamp<br>Collier Clamp<br>Abrazadera Clamp                 |
| 8. Anello di tenuta OR<br>OR seal ring<br>Joint torique<br>Junta OR                                      | 35. Rondella PTFE<br>PTFE washer<br>Rondelle PTFE<br>Arandela PTFE               |
| 9. Otturatore v. pn. 2 vie<br>Shutter 2-way pn. v.<br>Obturateur v. pn. 2 v.<br>Obturador v. neum. 2 v.  | 36. Anello di tenuta OR<br>OR seal ring<br>Joint torique<br>Junta OR             |
| 10. Otturatore v. pn. 3 vie<br>Shutter 3-way pn. v.<br>Obturateur v. pn. 3 v.<br>Obturador v. neum. 3 v. | 37. Lanterna<br>Lantern<br>Lanterne<br>Linterna                                  |
| 11. Guarnizione a labbro<br>Lip gasket<br>Joint à lèvres<br>Junta de reborde                             | 38. Vite<br>Screw<br>Vis<br>Tornillo   |
| 12. Ghiera di bloccaggio<br>Locking collar<br>Bague de blocage<br>Tuerca de seguridad                    | 39. Anello di raccordo<br>Joining ring<br>Bague de raccord<br>Anillo de conexión |
| 13. Distanziale<br>Spacer<br>Entretoise<br>Distanciador  | 40. Vite<br>Screw<br>Vis<br>Tornillo   |
| 14. Anello di tenuta OR<br>OR seal ring<br>Joint torique<br>Junta OR                                     | 41. Tappo<br>Blank<br>Bouchon<br>Tapón   |
| 15. Anello di tenuta OR<br>OR seal ring<br>Joint torique<br>Junta OR                                     | 42. Anello di tenuta OR<br>Or seal ring<br>Joint torique<br>Junta OR             |
| 16. Pistone<br>Piston<br>Piston<br>Pistón  |  |



COMBINAZIONI  
BODY COMBINATIONS  
COMBINAISONS  
COMBINACIONES

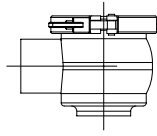

L

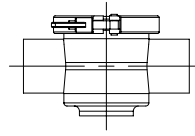

T

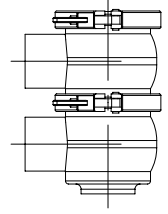

LL

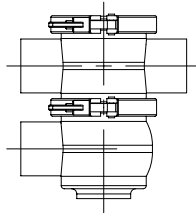

TL

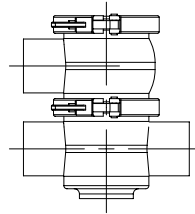

LT

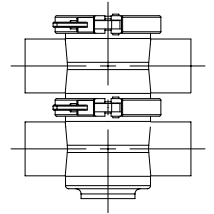

TT

DIAGRAMMI DI FLUSSO  
FLOWCHARTS  
DIAGRAMMES DE FLUX  
DIAGRAMAS DE FLUJO

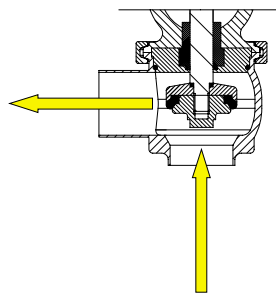

L

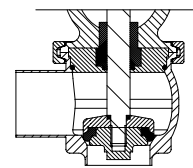

T

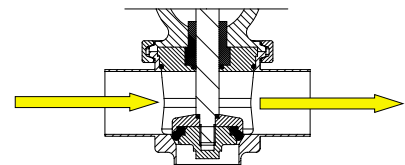
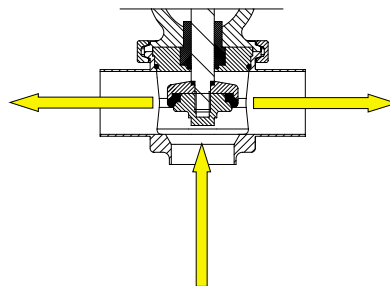

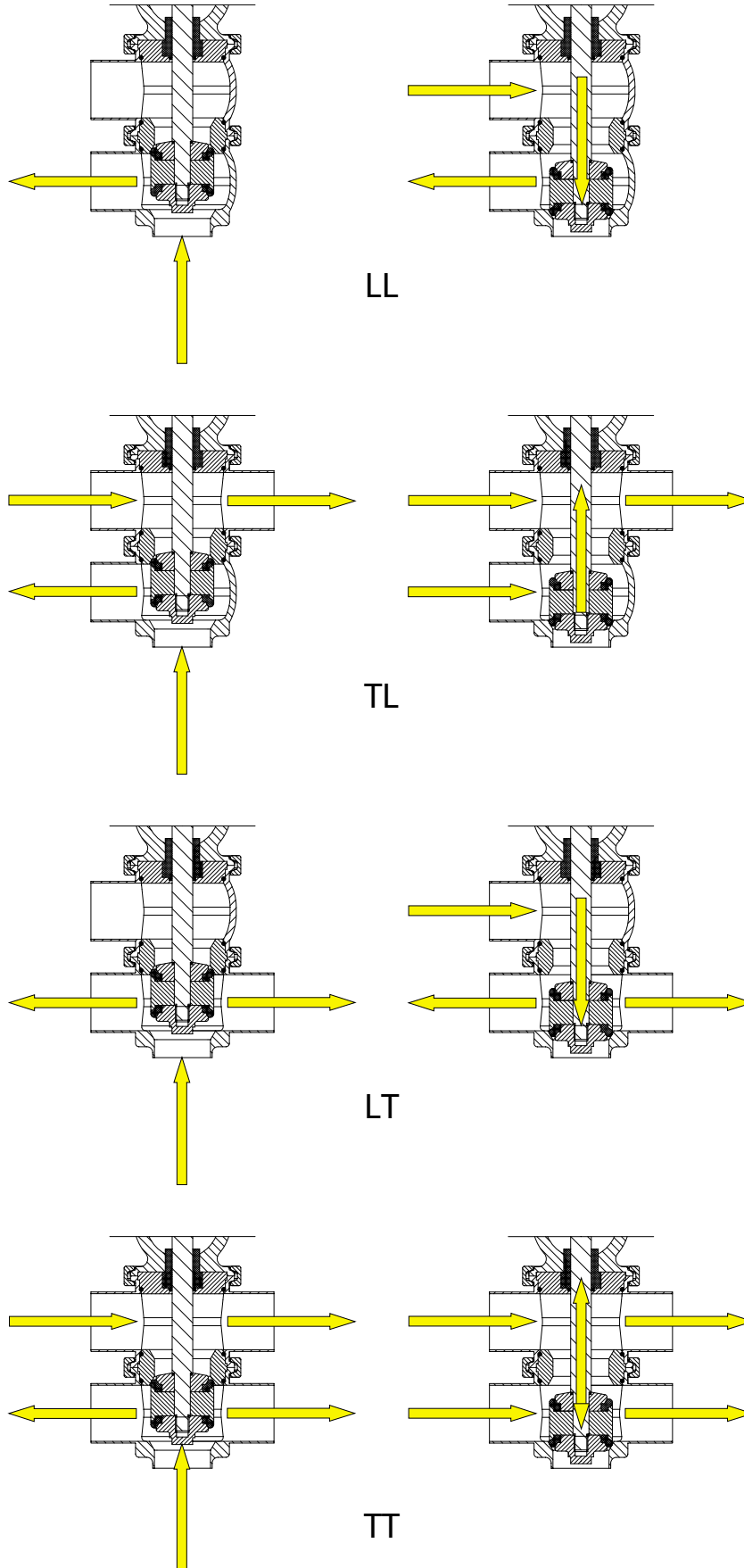



PERDITE DI CARICO  
 PRESSURE DROP  
 PERTES DE CHARGE  
 PÉRDIDA DE CARGA

VALVOLA PNEUMATICA 2 VIE L  
 TWO-WAY PNEUMATIC VALVE L

VANNE PNEUMATIQUE 2 VOIES L  
 VÁLVULA NEUMÁTICA 2 VÍAS L

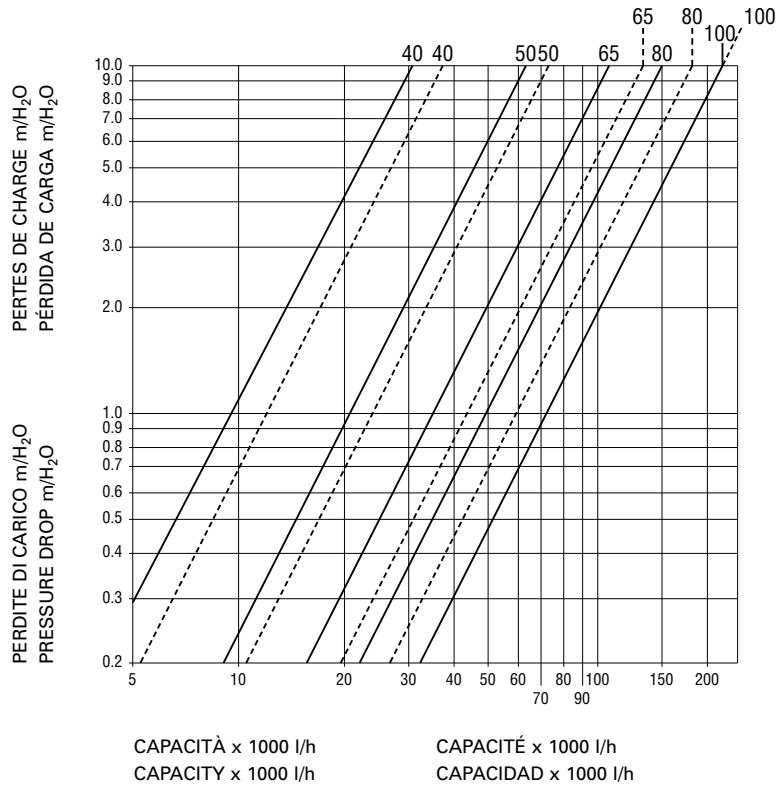

VALVOLA PNEUMATICA 3 VIE LL  
 THREE-WAY PNEUMATIC VALVE LL

VANNE PNEUMATIQUE 3 VOIES LL  
 VÁLVULA NEUMÁTICA 3 VÍAS LL

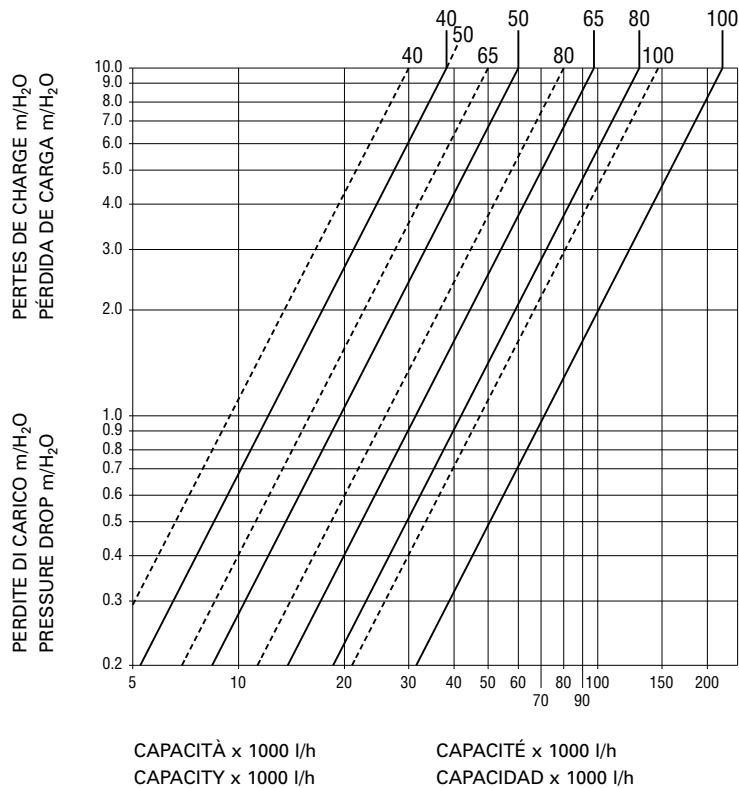



V. PNEUM. 3-A 2 V. L EL.  
PNEUM. V. 3-A 2 W. L PE.  
V. PNEUM. 3-A 2 V. L BL.  
V. NEUM. 3-A 2 V. L EL.

**900 L**

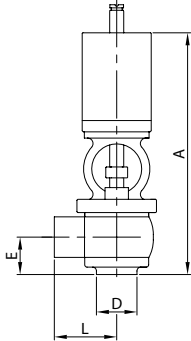

| DN        | A     | D     | E    | L     | gr     |
|-----------|-------|-------|------|-------|--------|
| 1" 25     | 241,0 | 25,4  | 38,0 | 50,0  | 4.320  |
| 1 1/2" 38 | 253,0 | 38,1  | 44,0 | 56,0  | 4.620  |
| 2" 51     | 310,0 | 50,8  | 48,0 | 65,0  | 9.500  |
| 2 1/2" 63 | 326,0 | 63,5  | 54,0 | 78,0  | 13.080 |
| 3" 76     | 364,0 | 76,2  | 64,0 | 84,0  | 15.000 |
| 4" 101    | 454,0 | 101,6 | 90,0 | 135,0 | 27.000 |

V. PNEUM. 3-A 2 V. L E. SM.  
PNEUM. V. 3-A 2 W. L E. FR.  
V. PNEUM. 3-A 2 V. L B. FR.  
V. NEUM. 3-A 2 V. L E. SM.

**901 K**

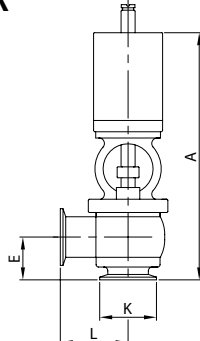

| DN        | A     | E     | K     | L     | gr     |
|-----------|-------|-------|-------|-------|--------|
| 1" 25     | 253,7 | 50,7  | 50,5  | 62,7  | 4.340  |
| 1 1/2" 38 | 265,7 | 56,7  | 50,5  | 68,7  | 4.650  |
| 2" 51     | 322,7 | 60,7  | 64,0  | 77,7  | 9.550  |
| 2 1/2" 63 | 338,7 | 66,7  | 77,0  | 90,7  | 13.140 |
| 3" 76     | 376,7 | 76,7  | 91,0  | 96,7  | 15.070 |
| 4" 101    | 469,8 | 105,8 | 119,0 | 150,8 | 27.130 |

V. PNEUM. 3-A 3 V. T EL.  
PNEUM. V. 3-A 3 W. T PE.  
V. PNEUM. 3-A 3 V. T BL.  
V. NEUM. 3-A 3 V. T EL.

**905 L**

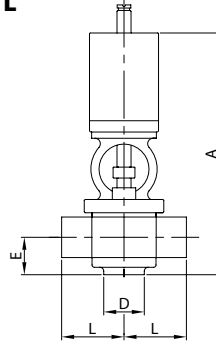

| DN        | A     | D     | E    | L     | gr     |
|-----------|-------|-------|------|-------|--------|
| 1" 25     | 241,0 | 25,4  | 38,0 | 50,0  | 4.330  |
| 1 1/2" 38 | 253,0 | 38,1  | 44,0 | 56,0  | 4.640  |
| 2" 51     | 310,0 | 50,8  | 48,0 | 65,0  | 9.530  |
| 2 1/2" 63 | 326,0 | 63,5  | 54,0 | 78,0  | 13.120 |
| 3" 76     | 364,0 | 76,2  | 64,0 | 84,0  | 15.050 |
| 4" 101    | 454,0 | 101,6 | 90,0 | 135,0 | 27.090 |

V. PNEUM. 3-A 3 V. T E. SM.  
PNEUM. V. 3-A 3 W. T E. FR.  
V. PNEUM. 3-A 3 V. T B. FR.  
V. NEUM. 3-A 3 V. T E. SM.

**906 K**

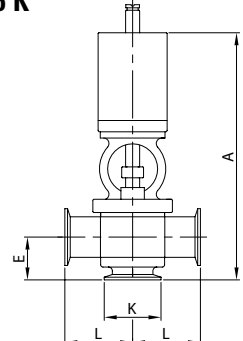

| DN        | A     | E     | K     | L     | gr     |
|-----------|-------|-------|-------|-------|--------|
| 1" 25     | 253,7 | 50,7  | 50,5  | 62,7  | 4.360  |
| 1 1/2" 38 | 265,7 | 56,7  | 50,5  | 68,7  | 4.700  |
| 2" 51     | 322,7 | 60,7  | 64,0  | 77,7  | 9.600  |
| 2 1/2" 63 | 338,7 | 66,7  | 77,0  | 90,7  | 13.210 |
| 3" 76     | 376,7 | 76,7  | 91,0  | 96,7  | 15.160 |
| 4" 101    | 469,8 | 105,0 | 119,0 | 150,8 | 27.290 |

V. PNEUM. 3-A 3 V. LL EL.  
PNEUM. V. 3-A 3 W. LL PE.  
V. PNEUM. 3-A 3 V. LL BL.  
V. NEUM. 3-A 3 V. LL EL.

**910 L**

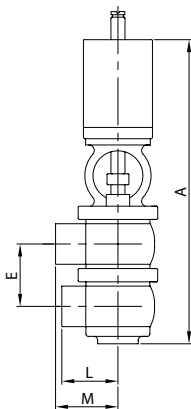

| DN        | A     | E     | L     | M     | gr     |
|-----------|-------|-------|-------|-------|--------|
| 1" 25     | 295,0 | 54,0  | 50,0  | 60,0  | 5.460  |
| 1 1/2" 38 | 320,0 | 67,0  | 56,0  | 65,0  | 6.360  |
| 2" 51     | 390,0 | 80,0  | 65,0  | 80,0  | 10.280 |
| 2 1/2" 63 | 422,0 | 96,0  | 78,0  | 100,0 | 17.280 |
| 3" 76     | 467,0 | 103,0 | 84,0  | 106,0 | 18.600 |
| 4" 101    | 625,0 | 157,0 | 135,0 | 135,0 | 31.000 |

V. PNEUM. 3-A 3 V. LL E. SM.  
PNEUM. V. 3-A 3 W. LL E. FR.  
V. PNEUM. 3-A 3 V. LL B. FR.  
V. NEUM. 3-A 3 V. LL E. SM.

**911 K**

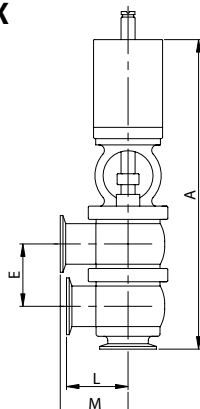

| DN        | A     | E     | L     | M     | gr     |
|-----------|-------|-------|-------|-------|--------|
| 1" 25     | 307,7 | 54,0  | 62,7  | 72,7  | 5.490  |
| 1 1/2" 38 | 332,7 | 67,0  | 68,7  | 77,7  | 6.400  |
| 2" 51     | 402,7 | 80,0  | 77,7  | 92,7  | 10.350 |
| 2 1/2" 63 | 434,7 | 96,0  | 90,7  | 112,7 | 17.370 |
| 3" 76     | 479,7 | 103,0 | 96,7  | 118,7 | 18.700 |
| 4" 101    | 640,8 | 157,0 | 150,8 | 150,8 | 31.180 |

V. PNEUM. 3-A 4 V. TL EL.  
PNEUM. V. 3-A 4 W. TL PE.  
V. PNEUM. 3-A 4 V. TL BL.  
V. NEUM. 3-A 4 V. TL EL.

**920 L**

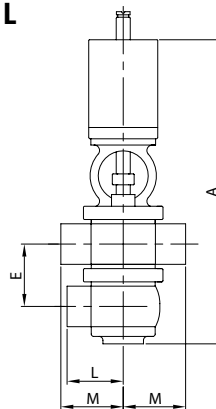

| DN        | A     | E     | L     | M     | gr     |
|-----------|-------|-------|-------|-------|--------|
| 1" 25     | 295,0 | 54,0  | 50,0  | 60,0  | 5.470  |
| 1 1/2" 38 | 320,0 | 67,0  | 56,0  | 65,0  | 6.380  |
| 2" 51     | 390,0 | 80,0  | 65,0  | 80,0  | 10.310 |
| 2 1/2" 63 | 422,0 | 96,0  | 78,0  | 100,0 | 17.320 |
| 3" 76     | 467,0 | 103,0 | 84,0  | 106,0 | 18.650 |
| 4" 101    | 625,0 | 157,0 | 135,0 | 135,0 | 31.090 |

V. PNEUM. 3-A 4 V. TL E. SM.  
PNEUM. V. 3-A 4 W. TL E. FR.  
V. PNEUM. 3-A 4 V. TL B. FR.  
V. NEUM. 3-A 4 V. TL E. SM.

**921 K**

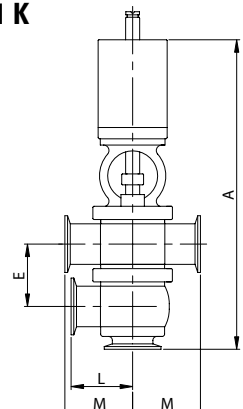

| DN        | A     | E     | L     | M     | gr     |
|-----------|-------|-------|-------|-------|--------|
| 1" 25     | 307,7 | 54,0  | 62,7  | 72,7  | 5.510  |
| 1 1/2" 38 | 332,7 | 67,0  | 68,7  | 77,7  | 6.440  |
| 2" 51     | 402,7 | 80,0  | 77,7  | 92,7  | 10.410 |
| 2 1/2" 63 | 434,7 | 96,0  | 90,7  | 112,7 | 17.440 |
| 3" 76     | 479,7 | 103,0 | 96,7  | 118,7 | 18.790 |
| 4" 101    | 640,8 | 157,0 | 150,8 | 150,8 | 31.340 |





V. PNEUM. 3-A 5 V. TT EL.  
PNEUM. V. 3-A 5 W. TT PE.  
V. PNEUM. 3-A 5 V. TT BL.  
V. NEUM. 3-A 5 V. TT EL.

**925 L**

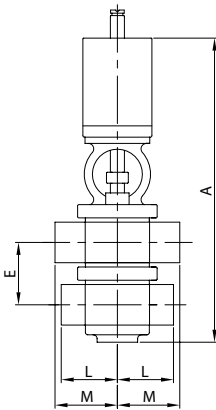

| DN        | A     | E     | L     | M     | gr     |
|-----------|-------|-------|-------|-------|--------|
| 1" 25     | 295,0 | 54,0  | 50,0  | 60,0  | 5.480  |
| 1 1/2" 38 | 320,0 | 67,0  | 56,0  | 65,0  | 6.400  |
| 2" 51     | 390,0 | 80,0  | 65,0  | 80,0  | 10.340 |
| 2 1/2" 63 | 422,0 | 96,0  | 78,0  | 100,0 | 17.360 |
| 3" 76     | 467,0 | 103,0 | 84,0  | 106,0 | 18.700 |
| 4" 101    | 625,0 | 157,0 | 135,0 | 135,0 | 31.180 |

V. PNEUM. 3-A 5 V. TT E. SM.  
PNEUM. V. 3-A 5 W. TT E. FR.  
V. PNEUM. 3-A 5 V. TT B. FR.  
V. NEUM. 3-A 5 V. TT E. SM.

**926 K**

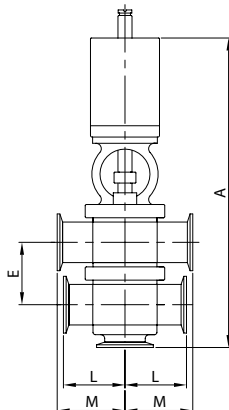

| DN        | A     | E     | L     | M     | gr     |
|-----------|-------|-------|-------|-------|--------|
| 1" 25     | 307,7 | 54,0  | 62,7  | 72,7  | 5.530  |
| 1 1/2" 38 | 332,7 | 67,0  | 68,7  | 77,7  | 6.470  |
| 2" 51     | 402,7 | 80,0  | 77,7  | 92,7  | 10.460 |
| 2 1/2" 63 | 434,7 | 96,0  | 90,7  | 112,7 | 17.510 |
| 3" 76     | 479,7 | 103,0 | 96,7  | 118,7 | 18.870 |
| 4" 101    | 640,8 | 157,0 | 150,8 | 150,8 | 31.350 |

ELETTOVALVOLA  
SOLENOID VALVE  
ÉLECTROVANNE  
ELECTROVÁLVULA

**015 NC**

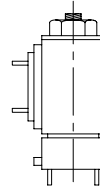

**015 NA**

MICROINTERRUPTORE  
MICROSWITCH  
MINIRUPTEUR  
MICROINTERRUPTOR

**014 1**

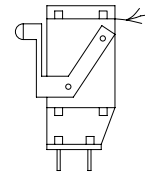

CONTATTO DI PROSSIMITÀ  
PROXIMITY CONTACT  
CONTACT DE PROXIMITÉ  
MICROSENSOR

**013 S**

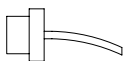

CONTATTO DI PROSSIMITÀ  
PROXIMITY CONTACT  
CONTACT DE PROXIMITÉ  
MICROSENSOR

**013 A**  
**013 A/N**  
**013 A/N/EX**

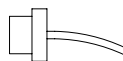

CONNETTORE  
CONNECTOR  
CONNECTEUR  
CONECTOR

**030 H**

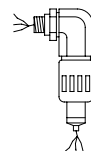

**030 S**

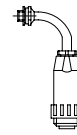

UNITÀ DI CONTROLLO  
CONTROL UNIT  
UNITÉ DE CONTRÔLE  
UNIDAD DE CONTROL

**900 UC 4**

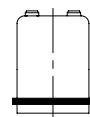



## VALVOLE A MEMBRANA

- Realizzate seguendo rigorosamente i criteri e i test imposti dalle norme 3-A.
- Corpo realizzato mediante stampaggio a caldo, solubilizzato, lavorato meccanicamente e lucidato.
- Comandi manuali e pneumatici in acciaio inossidabile AISI 316L per sterilizzazioni a elevate temperature.
- Membrane in EPDM o PTFE. Membrane in EPDM e supporti elastici per le membrane in PTFE telati per conferire maggiore resistenza meccanica.
- Perfetta tenuta e completo isolamento da fattori inquinanti esterni.
- Completo autodrenaggio di tutte le parti interne durante le fasi di lavaggio CIP.
- Manutenzioni ridotte "top entry" con facilità di accesso e senza necessità di smontare la valvola dall'impianto.

## DIAPHRAGM VALVES

- Produced in strict conformity with criteria and tests required by 3-A standards.
- Press-forged, solution heat-treated, machined and polished body.
- AISI 316L manual and pneumatic controls for high temperature sterilization.
- EPDM or PTFE diaphragms. EPDM diaphragms and elastic support for the PTFE diaphragms fabric-finished to give high mechanical strength.
- Perfect seal and complete insulation from external pollutants.
- Complete self-drainage of all internal parts during CIP process.
- Reduced top-entry maintenance with easy access and no need to remove the valve from the system.





## VANNES À MEMBRANE

- Réalisées en respectant scrupuleusement les critères et les tests imposés par les normes 3-A.
- Corps réalisé par moulage à chaud, solubilisé, usiné mécaniquement et poli.
- Commandes manuelles et pneumatiques en acier inoxydable AISI 316L pour les stérilisations aux hautes températures.
- Membrane en EPDM ou PTFE. Membranes en EPDM et supports élastiques pour les membranes en PTFE toilées pour conférer une meilleure résistance mécanique.
- Étanchéité parfaite et isolation complète contre les facteurs polluants extérieurs.
- Autodrainage complet de toutes les parties internes durant les opérations de lavage CIP.
- Opérations d'entretien réduites "top entry", facilité d'accès et aucune nécessité de démonter la vanne de l'installation.

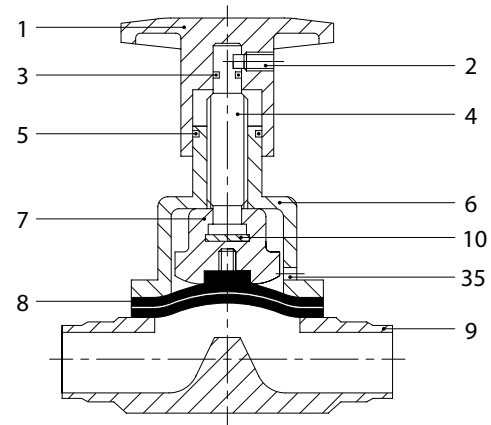

- |   |  |
|---|--|
| 1. Volantino<br>Handwheel<br>Volant<br>Manivela                     | 6. Comando<br>Control<br>Commande<br>Mando   |
| 2. Grano<br>Dowel<br>Cheville<br>Pasador                            | 7. Compressore<br>Compressor<br>Compresseur<br>Compressor  |
| 3. Anello di tenuta OR<br>OR seal ring<br>Joint torique<br>Junta OR | 8. Membrana<br>Diaphragm<br>Membrane<br>Membrana   |
| 4. Stelo<br>Spindle<br>Tige<br>Varilla                              | 9. Corpo valvola<br>Valve casing<br>Corps vanne<br>Cuerpo  |
| 5. Anello di tenuta OR<br>OR seal ring<br>Joint torique<br>Junta OR | 10. Reggispinta<br>Thrust bearing<br>Butée<br>Cojinete de empuje   |
|   | 35. Foro rilevaz. perdita<br>Leakage detection hole<br>Trous relèvement pertes<br>Orificio desc. pérdida |

## VÁLVULAS DE MEMBRANA

- Realizadas respetando rigurosamente los criterios y los tests establecidos por las normas 3-A.
- Cuerpo realizado mediante estampado en caliente, solubilizado, trabajado mecánicamente y pulido.
- Mandos manuales y neumáticos de acero inoxidable AISI 316L para esterilizaciones a elevadas temperaturas.
- Membranas de EPDM o PTFE. Membranas de EPDM y soportes elásticos para las membranas de PTFE entretelados para otorgar mayor resistencia mecánica.
- Cierre perfecto y aislamiento completo de factores contaminantes exteriores.
- Autodrenaje completo de todas las piezas interiores durante el proceso de lavado CIP.
- Mantenimientos reducidos "top entry" con facilidad de acceso y sin necesidad de desmontar la válvula del sistema.

MEMBRANE  
DIAPHRAGMS  
MEMBRANES  
MEMBRANAS

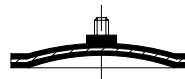

- EPDM  
-40°C +150°C  
-40°F +300°F

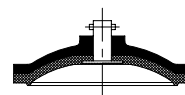

- PTFE  
-10°C +150°C  
-15°F +300°F



CONNESSIONI  
ENDS  
BOUTS  
EXTREMOS

| DN | BS    |                   |                  | SCHEDULE |           |            |            | ISO  |     | DIN     |      |         |      |         |   |
|----|-------|-------------------|------------------|----------|-----------|------------|------------|------|-----|---------|------|---------|------|---------|---|
|    | D.E.  | +16<br>swg<br>Sp. | 18<br>swg<br>Sp. | D.E.     | 5S<br>Sp. | 10S<br>Sp. | 40S<br>Sp. | D.E. | Sp. | Serie 1 |      | Serie 2 |      | Serie 3 |   |
|    |       | Sp.               | Sp.              |          | Sp.       | Sp.        | D.E.       |      |     | Sp.     | D.E. | Sp.     | D.E. | Sp.     |   |
| 15 | 12,70 | 1,63              | 1,22             | 21,34    | 1,65      | 2,11       | 2,77       | 21,3 | 1,6 | 18      | 1    | 19      | 1,5  | 20      | 2 |
| 20 | 19,05 | 1,63              | 1,22             | 26,67    | 1,65      | 2,11       | 2,87       | 26,9 | 1,6 | 22      | 1    | 23      | 1,5  | 24      | 2 |
| 25 | 25,40 | 1,63              | 1,22             | 33,40    | 1,65      | 2,77       | 3,38       | 33,7 | 2,0 | 28      | 1    | 29      | 1,5  | 30      | 2 |
| 40 | 38,10 | 1,63              | 1,22             | 48,26    | 1,65      | 2,77       | 3,68       | 48,3 | 2,0 | 40      | 1    | 41      | 1,5  | 42      | 2 |
| 50 | 50,80 | 1,63              | 1,22             | 60,33    | 1,65      | 2,77       | 3,91       | 60,3 | 2,6 | 52      | 1    | 53      | 1,5  | 54      | 2 |

VALORI CV E KV  
CV AND KV VALUES  
VALEURS CV ET KV  
VALORES CV Y KV

| %   | DN 15<br>1/2" |       | DN 20<br>3/4" |       | DN 25<br>1"  |       | DN 40<br>1 1/2" |       | DN 50<br>2"  |       |
|-----|---------------|-------|---------------|-------|--------------|-------|-----------------|-------|--------------|-------|
|     | CV            | KV    | CV            | KV    | CV           | KV    | CV              | KV    | CV           | KV    |
|     | (US gal/min)  | (l/s) | (US gal/min)  | (l/s) | (US gal/min) | (l/s) | (US gal/min)    | (l/s) | (US gal/min) | (l/s) |
| 100 | 6,7           | 1,6   | 13,3          | 3,16  | 20           | 4,76  | 50              | 12    | 101          | 24,04 |
| 90  | 6,4           | 1,5   | 12,8          | 3,04  | 19,2         | 4,57  | 48              | 11,4  | 97           | 23,1  |
| 80  | 6,11          | 1,45  | 12,3          | 2,9   | 18,4         | 4,37  | 46              | 11    | 92,9         | 22,1  |
| 70  | 5,85          | 1,4   | 11,7          | 2,8   | 17,6         | 4,2   | 44              | 10,5  | 88,9         | 21,15 |
| 60  | 5,58          | 1,32  | 11,2          | 2,65  | 16,8         | 4     | 42              | 10    | 84,83        | 20,2  |
| 50  | 4,65          | 1,1   | 9,3           | 2,2   | 14           | 3,33  | 35              | 8,4   | 10,7         | 16,83 |
| 40  | 3,7           | 0,9   | 7,45          | 1,76  | 11,2         | 2,66  | 28              | 6,7   | 56,5         | 13,46 |
| 30  | 2,8           | 0,65  | 5,6           | 1,3   | 8,4          | 2     | 21              | 5     | 42,4         | 10,1  |
| 20  | 1,85          | 0,43  | 3,7           | 0,9   | 5,6          | 1,33  | 14              | 3,8   | 28,27        | 6,73  |
| 10  | 0,92          | 0,21  | 1,85          | 0,43  | 2,8          | 0,66  | 7               | 1,66  | 14,13        | 3,36  |
| 0   | 0             |       | 0             |       | 0            |       | 0               |       | 0            |       |

DIMENSIONI, VOLUMI E TEMPI DI MANOVRA  
DIMENSIONS, AIR VOLUMES AND OPERATING TIMES  
DIMENSIONES, VOLUMES ET TEMPS DE MANOEUVRE  
DIMENSIONES, VOLUMENES Y TIEMPOS DE MANIOBRA

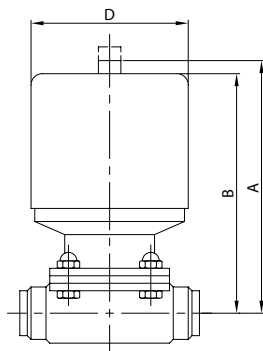

| Diam. valvola<br>Valve diam.<br>Diam. vanne<br>Diam. válvula | A   | B   | D   | Vol.<br>Aria chiude<br>Air closes<br>Air ferme<br>Aire cierra | Vol.<br>Aria apre<br>Air opens<br>Air ouvre<br>Aire abre | Tempi<br>Time<br>Temps<br>Tiempos |
|--|-----|-----|-----|---|--|-----------------------------------|
| mm   | mm  | mm  | mm  | cm <sup>3</sup>   | cm <sup>3</sup>  | s                                 |
| 15   | 125 | 120 | 70  | 50  | 20   | 1                                 |
| 20   | 140 | 135 | 89  | 230   | 65   | 1                                 |
| 25   | 145 | 140 | 89  | 230   | 65   | 1                                 |
| 40   | 208 | 203 | 129 | 1000  | 250  | 2                                 |
| 50   | 220 | 215 | 129 | 1000  | 350  | 2                                 |

| Diam. valvola<br>Valve diam.<br>Diam. vanne<br>Diam. válvula | A      | B      | D      | Vol.<br>Aria chiude<br>Air closes<br>Air ferme<br>Aire cierra | Vol.<br>Aria apre<br>Air opens<br>Air ouvre<br>Aire abre | Tempi<br>Time<br>Temps<br>Tiempos |
|--|--------|--------|--------|---|--|-----------------------------------|
| in   | in     | in     | in     | in <sup>3</sup>   | in <sup>3</sup>  | s                                 |
| 1/2"   | 5"     | 4 3/4" | 2 3/4" | 3   | 1  | 1                                 |
| 3/4"   | 5 1/2" | 5 3/8" | 3 1/2" | 13  | 4  | 1                                 |
| 1"   | 5 3/4" | 5 1/2" | 3 1/2" | 13  | 4  | 1                                 |
| 1 1/2"   | 8"     | 8"     | 5"     | 60,5  | 15   | 2                                 |
| 2"   | 9"     | 8 1/2" | 5"     | 61  | 20   | 2                                 |



MICROVALVOLA M. EL.  
D. MICROVALVE PE.  
MINIVANNE MEMBR. EL.  
MICROVALVULA M. EL.

**S57W**

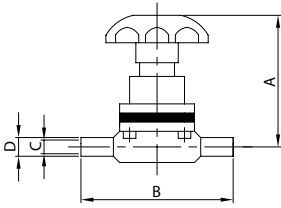

| DN      | A    | B    | C   | D    | gr  |
|---------|------|------|-----|------|-----|
| 1/4" 6  | 66,5 | 67,0 | 3,9 | 6,3  | 190 |
| 3/8" 9  | 66,5 | 67,0 | 7,1 | 9,5  | 190 |
| 1/2" 12 | 66,5 | 67,0 | 9,4 | 12,7 | 190 |

MICROVALVOLA M. E. SM.  
D. MICROVALVE E. FR.  
MINIVANNE MEMBR. B. FR.  
MICROVALVULA M. E. SM.

**S57K**

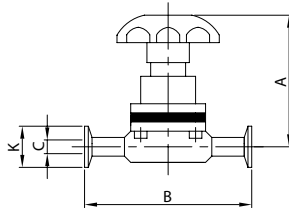

| DN      | A    | B    | C   | K    | gr  |
|---------|------|------|-----|------|-----|
| 1/2" 12 | 66,5 | 67,0 | 9,4 | 25,0 | 200 |

V. MEMBRANA EL.  
DIAPHRAGM V. PE.  
V. MEMBRANA BL.  
V. MEMBRANA EL.

**57W**

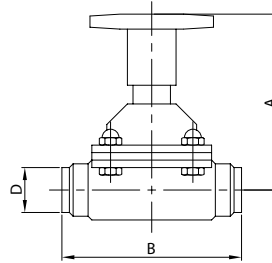

| DN        | A     | B     | D    | gr    |
|-----------|-------|-------|------|-------|
| 1/2" 12   | 78,0  | 89,0  | 12,7 | 840   |
| 3/4" 19   | 79,0  | 102,0 | 19,0 | 1.200 |
| 1" 25     | 92,0  | 114,0 | 25,4 | 1.680 |
| 1 1/2" 38 | 112,0 | 140,0 | 38,1 | 3.140 |
| 2" 51     | 135,0 | 159,0 | 50,8 | 5.040 |

V. MEMBRANA E. SM.  
DIAPHRAGM V. E. FR.  
V. MEMBRANA B. FR.  
V. MEMBRANA E. SM.

**57K**

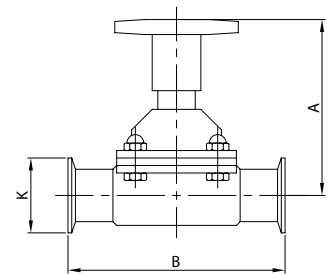

| DN        | A     | B     | K    | gr    |
|-----------|-------|-------|------|-------|
| 1/2" 12   | 78,0  | 89,0  | 25,0 | 840   |
| 3/4" 19   | 79,0  | 102,0 | 25,0 | 1.200 |
| 1" 25     | 92,0  | 114,0 | 50,5 | 1.680 |
| 1 1/2" 38 | 112,0 | 140,0 | 50,5 | 3.140 |
| 2" 51     | 135,0 | 159,0 | 64,0 | 5.040 |

V. M. PNEUMATICA EL.  
PNEUMATIC D. V. PE.  
V. M. PNEUMATIQUE BL.  
V. M. NEUMÁTICA EL.

**58W**

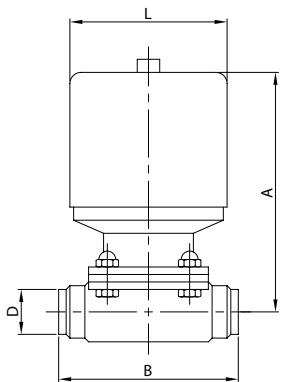

| DN        | A     | B     | D    | L     | gr    |
|-----------|-------|-------|------|-------|-------|
| 1/2" 12   | 110,0 | 89,0  | 12,7 | 60,0  | 1.360 |
| 3/4" 19   | 123,0 | 102,0 | 19,0 | 90,0  | 2.460 |
| 1" 25     | 129,0 | 114,0 | 25,4 | 90,0  | 2.780 |
| 1 1/2" 38 | 187,0 | 140,0 | 38,1 | 127,0 | 6.880 |
| 2" 51     | 198,0 | 159,0 | 50,8 | 127,0 | 8.160 |

V. M. PNEUMATICA E. SM.  
PNEUMATIC D. V. E. FR.  
V. M. PNEUMATIQUE B. FR.  
V. M. NEUMÁTICA E. SM.

**58K**

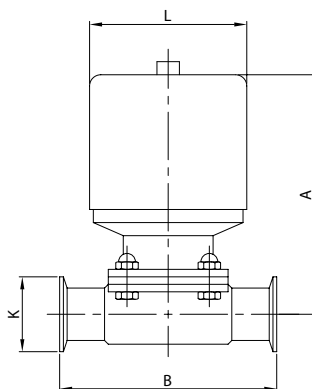

| DN        | A     | B     | K    | L     | gr    |
|-----------|-------|-------|------|-------|-------|
| 1/2" 12   | 111,0 | 89,0  | 25,0 | 60,0  | 1.360 |
| 3/4" 19   | 123,0 | 102,0 | 25,0 | 90,0  | 2.460 |
| 1" 25     | 129,0 | 114,0 | 50,5 | 90,0  | 2.780 |
| 1 1/2" 38 | 187,0 | 140,0 | 50,5 | 127,0 | 6.880 |
| 2" 51     | 198,0 | 159,0 | 64,0 | 127,0 | 8.160 |

V. M. UN. CONTROLLO EL.  
D. V. CONTROL UNIT PE.  
V. M. UN. CONTRÔLE BL.  
V. M. UN. CONTROL EL.

**60W**

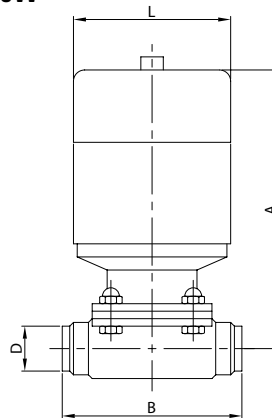

| DN        | A     | B     | D    | L     | gr    |
|-----------|-------|-------|------|-------|-------|
| 1/2" 12   | 153,0 | 89,0  | 12,7 | 60,0  | 1.660 |
| 3/4" 19   | 154,0 | 102,0 | 19,0 | 90,0  | 3.010 |
| 1" 25     | 167,0 | 114,0 | 25,4 | 90,0  | 3.330 |
| 1 1/2" 38 | 187,0 | 140,0 | 38,1 | 127,0 | 7.880 |
| 2" 51     | 210,0 | 159,0 | 50,8 | 127,0 | 9.160 |

V. M. UN. CONTROLLO E. SM.  
D. V. CONTROL UNIT E. FR.  
V. M. UN. CONTRÔLE B. FR.  
V. M. UN. CONTROL E. SM.

**60K**

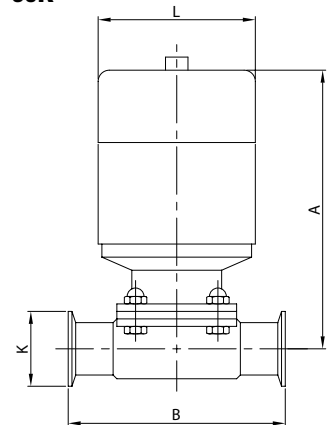

| DN        | A     | B     | K    | L     | gr    |
|-----------|-------|-------|------|-------|-------|
| 1/2" 12   | 153,0 | 89,0  | 25,0 | 60,0  | 1.660 |
| 3/4" 19   | 154,0 | 102,0 | 25,0 | 90,0  | 3.010 |
| 1" 25     | 167,0 | 114,0 | 50,5 | 90,0  | 3.330 |
| 1 1/2" 38 | 187,0 | 140,0 | 50,5 | 127,0 | 7.880 |
| 2" 51     | 210,0 | 159,0 | 64,0 | 127,0 | 9.160 |



V. MEMBRANA 3 V. T EL.  
DIAPHRAGM V. 3 W. T PE.  
V. MEMBRANE 3 V. T BL.  
V. MEMBRANA 3 V. T EL.

**ZDT 57W**

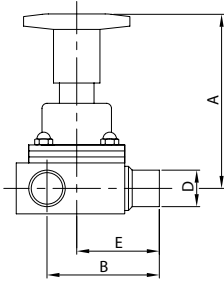

| DN        | A     | B     | D    | E    | gr    |
|-----------|-------|-------|------|------|-------|
| 1/2" 12   | 97,5  | 56,5  | 12,7 | 44,5 | 840   |
| 3/4" 19   | 99,0  | 66,5  | 19,0 | 51,0 | 1.200 |
| 1" 25     | 120,0 | 80,0  | 25,4 | 57,0 | 1.680 |
| 1 1/2" 38 | 156,0 | 101,5 | 38,1 | 70,0 | 3.140 |
| 2" 51     | 182,0 | 118,5 | 50,8 | 79,5 | 5.040 |

V. MEMBR. 3 V. T E. SM.  
DIAPHR. V. 3 W. T FR.  
V. MEMBR. 3 V. T B. FR.  
V. MEMBR. 3 V. T E. SM.

**ZDT 57K**

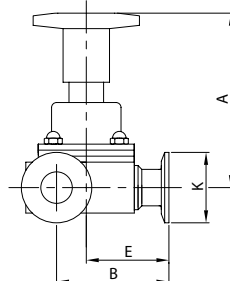

| DN        | A     | B     | E    | K    | gr    |
|-----------|-------|-------|------|------|-------|
| 1/2" 12   | 97,5  | 56,5  | 44,5 | 25,0 | 840   |
| 3/4" 19   | 99,0  | 66,5  | 51,0 | 25,0 | 1.200 |
| 1" 25     | 120,0 | 80,0  | 57,0 | 50,5 | 1.680 |
| 1 1/2" 38 | 156,0 | 101,5 | 70,0 | 50,5 | 3.140 |
| 2" 51     | 182,0 | 118,5 | 79,5 | 64,0 | 5.040 |

V. M. PNEUM. 3 V. T EL.  
PNEUM. D. V. 3 W. T PE.  
V. M. PNEUM. 3 V. T BL.  
V. M. NEUM. 3 V. T EL.

**ZDT 58W**

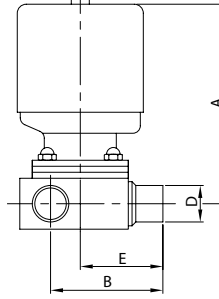

| DN        | A     | B     | D    | E    | gr    |
|-----------|-------|-------|------|------|-------|
| 1/2" 12   | 110,0 | 56,5  | 12,7 | 44,5 | 1.360 |
| 3/4" 19   | 123,0 | 66,5  | 19,0 | 51,0 | 2.460 |
| 1" 25     | 129,0 | 80,0  | 25,4 | 57,0 | 2.780 |
| 1 1/2" 38 | 188,0 | 101,5 | 38,1 | 70,0 | 6.880 |
| 2" 51     | 201,0 | 118,5 | 50,8 | 79,5 | 8.160 |

V. M. PN. 3 V. T E. SM.  
PN. D. V. 3 W. T E. FR.  
V. M. PN. 3 V. T B. FR.  
V. M. NEUM. 3 V. T E. SM.

**ZDT 58K**

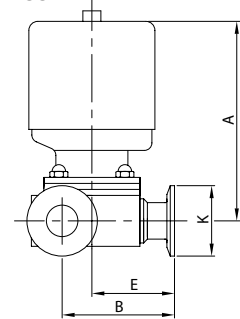

| DN        | A     | B     | E    | K    | gr    |
|-----------|-------|-------|------|------|-------|
| 1/2" 12   | 110,0 | 56,5  | 44,5 | 25,0 | 1.360 |
| 3/4" 19   | 123,0 | 66,5  | 51,0 | 25,0 | 2.460 |
| 1" 25     | 129,0 | 80,0  | 57,0 | 50,0 | 2.780 |
| 1 1/2" 38 | 188,0 | 101,5 | 70,0 | 50,5 | 6.880 |
| 2" 51     | 201,0 | 118,5 | 79,5 | 64,0 | 8.160 |

V. M. UN. C. 3 V. T EL.  
D. V. C. UNIT 3 W. T PE.  
V. M. UN. CONTR. 3 V. T BL.  
V. M. UN. CONTR. 3 V. T EL.

**ZDT 60W**

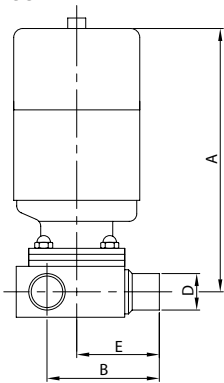

| DN        | A     | B     | D    | E    | gr    |
|-----------|-------|-------|------|------|-------|
| 1/2" 12   | 186,0 | 56,5  | 12,7 | 44,5 | 1.660 |
| 3/4" 19   | 198,0 | 66,5  | 19,0 | 51,0 | 3.010 |
| 1" 25     | 204,0 | 80,0  | 25,4 | 57,0 | 3.330 |
| 1 1/2" 38 | 263,0 | 101,5 | 38,1 | 70,0 | 7.880 |
| 2" 51     | 276,0 | 118,5 | 50,8 | 79,5 | 9.160 |

V. M. UN. C. 3 V T E. SM.  
D. V. C. UN. 3 W. T E. FR.  
V. M. UN. C. 3 V. T B. FR.  
V. M. UN. C. 3 V. T E. SM.

**ZDT 60K**

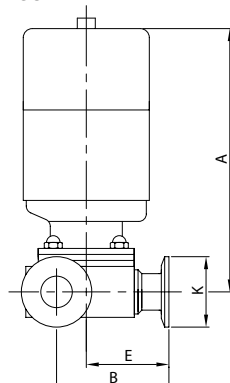

| DN        | A     | B     | E    | K    | gr    |
|-----------|-------|-------|------|------|-------|
| 1/2" 12   | 186,0 | 56,5  | 44,5 | 25,0 | 1.660 |
| 3/4" 19   | 198,0 | 66,5  | 51,0 | 25,0 | 3.010 |
| 1" 25     | 204,0 | 80,0  | 57,0 | 50,5 | 3.330 |
| 1 1/2" 38 | 263,0 | 101,5 | 70,0 | 50,5 | 7.880 |
| 2" 51     | 276,0 | 118,5 | 79,5 | 64,0 | 9.160 |

V. M. PRELIEVO EL.  
SAMPLING D. V. PE.  
V. M. PRISE ECHANT. EL.  
V. M. TOMAMUESTRAS EL.

**ZDL 57W**

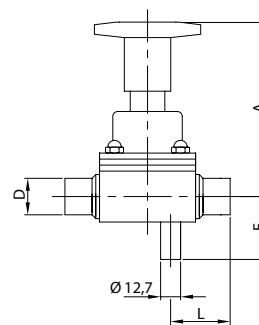

| DN        | A     | D    | E    | L    | gr    |
|-----------|-------|------|------|------|-------|
| 1/2" 12   | 94,5  | 12,7 | 34,5 | 27,0 | 840   |
| 3/4" 19   | 96,0  | 19,0 | 39,0 | 32,0 | 1.200 |
| 1" 25     | 116,0 | 25,4 | 42,0 | 37,0 | 1.680 |
| 1 1/2" 38 | 155,0 | 38,1 | 59,0 | 42,0 | 3.140 |
| 2" 51     | 182,0 | 50,8 | 66,0 | 46,0 | 5.040 |

V. M. PRELIEVO E. SM.  
SAMPLING D. V. E. FR.  
V. M. PRISE ECHANT. B. FR.  
V. M. TOMAM. E. SM.

**ZDL 57K**

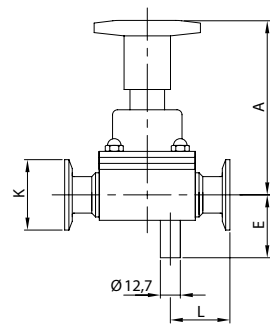

| DN        | A     | E    | K    | L    | gr    |
|-----------|-------|------|------|------|-------|
| 1/2" 12   | 94,5  | 34,5 | 25,0 | 27,0 | 840   |
| 3/4" 19   | 96,0  | 39,0 | 25,0 | 32,0 | 1.200 |
| 1" 25     | 116,0 | 42,0 | 50,5 | 37,0 | 1.680 |
| 1 1/2" 38 | 155,0 | 59,0 | 50,5 | 42,0 | 3.140 |
| 2" 51     | 182,0 | 66,0 | 64,0 | 46,0 | 5.040 |





V. M. PNEUM. PRELIEVO EL.  
SAMPLING PN. D. V. PE.  
V. M. PN. PRISE ECH. EL.  
V. M. NEUM. TOMAM. EL.

**ZDL 58W**

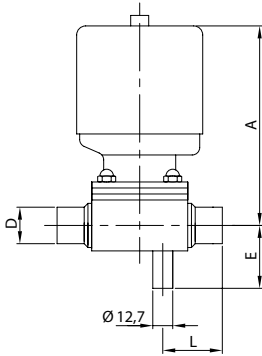

| DN        | A     | D    | E    | L    | gr    |
|-----------|-------|------|------|------|-------|
| 1/2" 12   | 107,0 | 12,7 | 34,5 | 27,0 | 1.360 |
| 3/4" 19   | 120,0 | 19,0 | 39,0 | 32,0 | 2.460 |
| 1" 25     | 125,0 | 25,4 | 42,0 | 37,0 | 2.780 |
| 1 1/2" 38 | 187,0 | 38,1 | 59,0 | 42,0 | 6.880 |
| 2" 51     | 201,0 | 50,8 | 66,0 | 46,0 | 8.160 |

V. M. PNEUM. PREL. E. SM.  
SAMPL. PN. D. V. E. FR.  
V. M. PN. PRISE ECH. B. FR.  
V. M. NEUM. TOMAM. E. SM.

**ZDL 58K**

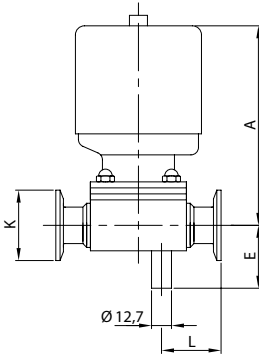

| DN        | A     | E    | K    | L    | gr    |
|-----------|-------|------|------|------|-------|
| 1/2" 12   | 107,0 | 34,5 | 25,0 | 27,0 | 1.360 |
| 3/4" 19   | 120,0 | 39,0 | 25,0 | 32,0 | 2.460 |
| 1" 25     | 125,0 | 42,0 | 50,5 | 37,0 | 2.780 |
| 1 1/2" 38 | 187,0 | 59,0 | 50,5 | 42,0 | 6.880 |
| 2" 51     | 201,0 | 66,0 | 64,0 | 46,0 | 8.160 |

V. M. U. C. PRELIEVO EL.  
SAMPLING D. V. C. UN. PE.  
V. M. U. C. PRISE ECH. BL.  
V. M. U. C. TOMAM. EL.

**ZDL 60W**

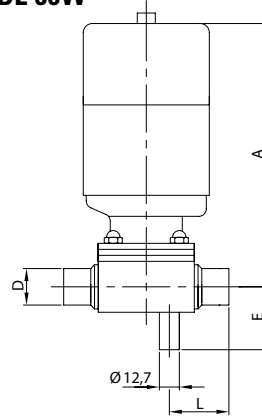

| DN        | A     | D    | E    | L    | gr    |
|-----------|-------|------|------|------|-------|
| 1/2" 12   | 183,0 | 12,7 | 34,5 | 27,0 | 1.660 |
| 3/4" 19   | 195,0 | 19,0 | 39,0 | 32,0 | 3.010 |
| 1" 25     | 200,0 | 25,4 | 42,0 | 37,0 | 3.330 |
| 1 1/2" 38 | 262,0 | 38,1 | 59,0 | 42,0 | 7.880 |
| 2" 51     | 276,0 | 50,8 | 66,0 | 46,0 | 9.160 |

V. M. U. C. PREL. E. SM.  
SAMPL. D. V. C. UN. E. FR.  
V. M. U. C. PRISE ECH. B. FR.  
V. M. U. C. TOMAM. E. SM.

**ZDL 60K**

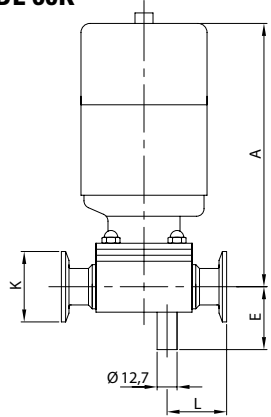

| DN        | A     | E    | K    | L    | gr    |
|-----------|-------|------|------|------|-------|
| 1/2" 12   | 183,0 | 34,5 | 25,0 | 27,0 | 1.660 |
| 3/4" 19   | 195,0 | 39,0 | 25,0 | 32,0 | 3.010 |
| 1" 25     | 200,0 | 42,0 | 50,5 | 37,0 | 3.330 |
| 1 1/2" 38 | 262,0 | 59,0 | 50,5 | 42,0 | 7.880 |
| 2" 51     | 276,0 | 66,0 | 64,0 | 46,0 | 9.160 |

V. M. PRELIEVO 20° EL.  
20° SAMPLING D. V. PE.  
V. M. PRISE ECH. 20° EL.  
V. M. TOMAM. 20° EL.

**D2L 57W**

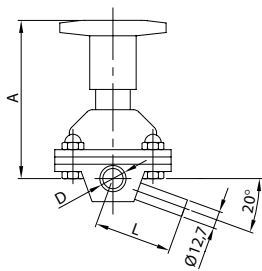

| DN        | A     | D    | L    | gr    |
|-----------|-------|------|------|-------|
| 1/2" 12   | 94,5  | 12,7 | 46,0 | 840   |
| 3/4" 19   | 96,0  | 19,0 | 50,0 | 1.200 |
| 1" 25     | 116,0 | 25,4 | 55,0 | 1.680 |
| 1 1/2" 38 | 155,0 | 38,1 | 71,0 | 3.140 |
| 2" 51     | 182,0 | 50,8 | 84,0 | 5.040 |

V. M. PRELIEVO 20° E. SM.  
20° SAMPLING D. V. E. FR.  
V. M. PRISE ECH. 20° B. FR.  
V. M. TOMAM. 20° E. SM.

**D2L 57K**

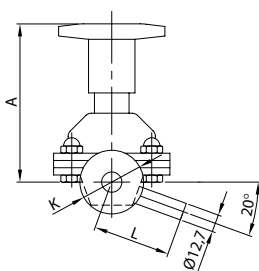

| DN        | A     | K    | L    | gr    |
|-----------|-------|------|------|-------|
| 1/2" 12   | 94,5  | 25,0 | 46,0 | 840   |
| 3/4" 19   | 96,0  | 25,0 | 50,0 | 1.200 |
| 1" 25     | 116,0 | 50,5 | 55,0 | 1.680 |
| 1 1/2" 38 | 155,0 | 50,5 | 71,0 | 3.140 |
| 2" 51     | 182,0 | 64,0 | 84,0 | 5.040 |

V. M. PNEUM. PREL. 20° EL.  
20° SAMPL. PN. D. V. PE.  
V. M. PN. PR. ECH. 20° BL.  
V. M. NEUM. TOMAM. 20° EL.

**D2L 58W**

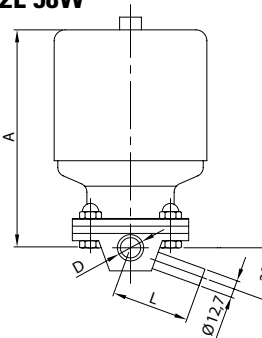

| DN        | A     | D    | L    | gr    |
|-----------|-------|------|------|-------|
| 1/2" 12   | 107,0 | 12,7 | 46,0 | 1.360 |
| 3/4" 19   | 120,0 | 19,0 | 50,0 | 2.460 |
| 1" 25     | 125,0 | 25,4 | 55,0 | 2.780 |
| 1 1/2" 38 | 187,0 | 38,1 | 71,0 | 6.880 |
| 2" 51     | 201,0 | 50,8 | 84,0 | 8.160 |

V. M. PN. PREL. 20° E. SM.  
20° SAMPL. PN. D. V. E. FR.  
V. M. PN. PR. ECH. 20° B. FR.  
V. M. N. TOMAM. 20° E. SM.

**D2L 58K**

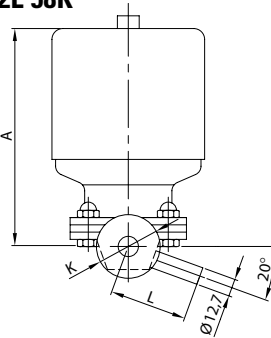

| DN        | A     | K    | L    | gr    |
|-----------|-------|------|------|-------|
| 1/2" 12   | 107,0 | 25,0 | 46,0 | 1.360 |
| 3/4" 19   | 120,0 | 25,0 | 50,0 | 2.460 |
| 1" 25     | 125,0 | 50,5 | 55,0 | 2.780 |
| 1 1/2" 38 | 187,0 | 50,5 | 71,0 | 6.880 |
| 2" 51     | 201,0 | 64,0 | 84,0 | 8.160 |



V. M. U. C. PREL. 20° EL.  
20° SAMPL. D. V. C. UN. PE.  
V. M. U. C. PR. ECH. 20° EL.  
V. M. U. C. TOMAM. 20° EL.

V. M. U. C. PREL. 20° E. SM.  
20° SAMPL. D. V. C. UN. E. FR.  
V. M. U. C. PR. ECH. 20° B. FR.  
V. M. U. C. TOMAM. 20° E. SM.

V. M. FONDO SERBATOIO EL.  
TANK BOTTOM D. V. PE.  
V. M. FOND CUVE BL.  
V. M. FONDO TANQUE EL.

V. M. FONDO SERB. E. SM.  
TANK BOTTOM D. V. E. FR.  
V. M. FOND CUVE B. FR.  
V. M. FONDO TANQUE E. SM.

**D2L 60W**

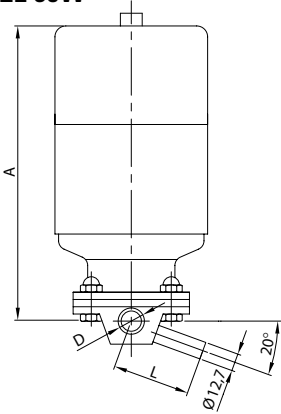

**D2L 60K**

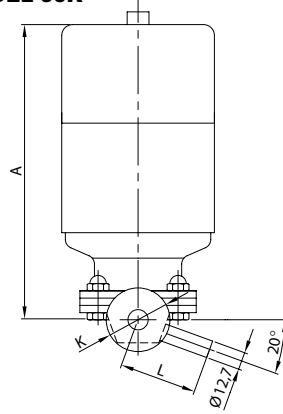

**KTB 57W**

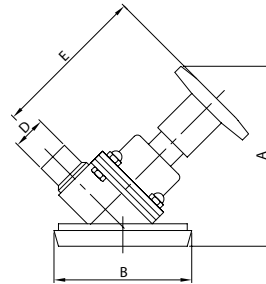

**KTB 57K**

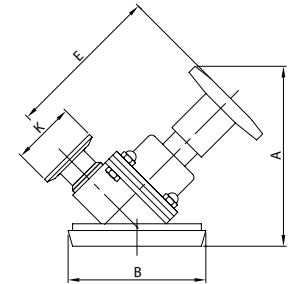

| DN        | A     | D    | L    | gr    |
|-----------|-------|------|------|-------|
| 1/2" 12   | 183,0 | 12,7 | 46,0 | 1.660 |
| 3/4" 19   | 195,0 | 19,0 | 50,0 | 3.010 |
| 1" 25     | 200,0 | 25,4 | 55,0 | 3.330 |
| 1 1/2" 38 | 262,0 | 38,1 | 71,0 | 7.880 |
| 2" 51     | 276,0 | 50,8 | 84,0 | 9.160 |

| DN        | A     | K    | L    | gr    |
|-----------|-------|------|------|-------|
| 1/2" 12   | 183,0 | 25,0 | 46,0 | 1.660 |
| 3/4" 19   | 195,0 | 25,0 | 50,0 | 3.010 |
| 1" 25     | 200,0 | 50,5 | 55,0 | 3.330 |
| 1 1/2" 38 | 262,0 | 50,5 | 71,0 | 7.880 |
| 2" 51     | 276,0 | 64,0 | 84,0 | 9.160 |

| DN        | A     | B     | D    | E     | gr    |
|-----------|-------|-------|------|-------|-------|
| 1/2" 12   | 117,0 | 68,0  | 12,7 | 94,5  | 1.040 |
| 3/4" 19   | 123,0 | 86,0  | 19,0 | 96,0  | 1.550 |
| 1" 25     | 142,0 | 100,0 | 25,4 | 116,0 | 2.030 |
| 1 1/2" 38 | 181,0 | 121,0 | 38,1 | 155,0 | 4.090 |
| 2" 51     | 206,0 | 150,0 | 50,8 | 182,0 | 7.090 |

| DN        | A     | B     | E     | K    | gr    |
|-----------|-------|-------|-------|------|-------|
| 1/2" 12   | 117,0 | 68,0  | 94,5  | 25,0 | 1.040 |
| 3/4" 19   | 123,0 | 86,0  | 96,0  | 25,0 | 1.550 |
| 1" 25     | 142,0 | 100,0 | 116,0 | 50,5 | 2.030 |
| 1 1/2" 38 | 181,0 | 121,0 | 155,0 | 50,5 | 4.090 |
| 2" 51     | 206,0 | 150,0 | 182,0 | 64,0 | 7.090 |

V. M. PNEUM. F. SERB. EL.  
TANK B. PNEUM. D. V. PE.  
V. M. PN. FOND CUVE BL.  
V. M. NEUM. F. TANQUE EL.

V. M. PN. F. SERB. E. SM.  
TANK B. PNEUM. D. V. E. FR.  
V. M. PN. FOND CUVE B. FR.  
V. M. N. F. TANQUE E. SM.

V. M. U. C. F. SERB. EL.  
TANK B. D. V. C. UN. PE.  
V. M. U. C. F. CUVE BL.  
V. M. U. C. F. TANQUE EL.

V. M. U. C. F. SERB. E. SM.  
TANK B. D. V. C. UN. E. FR.  
V. M. U. C. F. CUVE B. FR.  
V. M. U. C. F. TANQUE E. SM.

**KTB 58W**

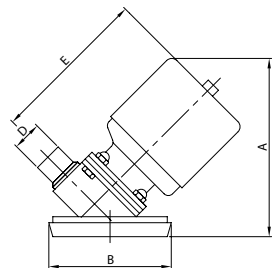

**KTB 58K**

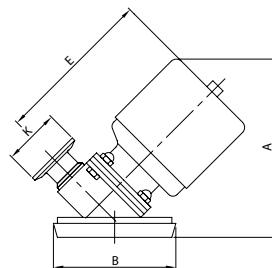

**KTB 60W**

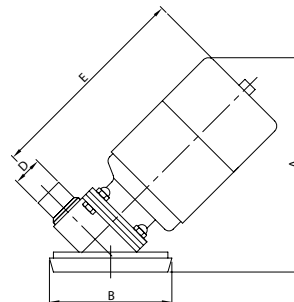

**KTB 60K**

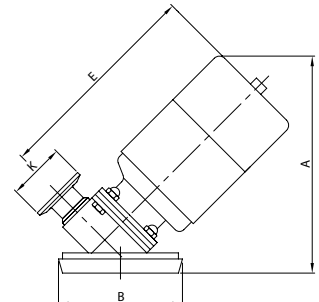

| DN        | A     | B     | D    | E     | gr     |
|-----------|-------|-------|------|-------|--------|
| 1/2" 12   | 125,0 | 68,0  | 12,7 | 107,0 | 1.560  |
| 3/4" 19   | 147,0 | 86,0  | 19,0 | 120,0 | 2.810  |
| 1" 25     | 152,0 | 100,0 | 25,4 | 125,0 | 3.130  |
| 1 1/2" 38 | 210,0 | 121,0 | 38,1 | 187,0 | 7.830  |
| 2" 51     | 227,0 | 150,0 | 50,8 | 201,0 | 10.210 |

| DN        | A     | B     | E     | K    | gr     |
|-----------|-------|-------|-------|------|--------|
| 1/2" 12   | 125,0 | 68,0  | 107,0 | 25,0 | 1.560  |
| 3/4" 19   | 147,0 | 86,0  | 120,0 | 25,0 | 2.810  |
| 1" 25     | 152,0 | 100,0 | 125,0 | 50,5 | 3.130  |
| 1 1/2" 38 | 210,0 | 121,0 | 187,0 | 50,5 | 7.830  |
| 2" 51     | 227,0 | 150,0 | 201,0 | 64,0 | 10.210 |

| DN        | A     | B     | D    | E     | gr     |
|-----------|-------|-------|------|-------|--------|
| 1/2" 12   | 187,0 | 68,0  | 12,7 | 183,0 | 1.860  |
| 3/4" 19   | 201,0 | 86,0  | 19,0 | 195,0 | 3.360  |
| 1" 25     | 204,0 | 100,0 | 25,4 | 200,0 | 3.680  |
| 1 1/2" 38 | 262,0 | 121,0 | 38,1 | 262,0 | 8.830  |
| 2" 51     | 274,0 | 150,0 | 50,8 | 276,0 | 11.210 |

| DN        | A     | B     | E     | K    | gr     |
|-----------|-------|-------|-------|------|--------|
| 1/2" 12   | 187,0 | 68,0  | 183,0 | 25,0 | 1.860  |
| 3/4" 19   | 201,0 | 86,0  | 195,0 | 25,0 | 3.360  |
| 1" 25     | 204,0 | 100,0 | 200,0 | 50,5 | 3.680  |
| 1 1/2" 38 | 262,0 | 121,0 | 262,0 | 50,5 | 8.830  |
| 2" 51     | 274,0 | 150,0 | 276,0 | 64,0 | 11.210 |



V. M. MODULANTE EL.  
MODULATING D. V. PE.  
V. M. MODULANTE BL.  
V. M. MODULANTE EL.

V. M. MODULANTE E. SM.  
MODULATING D. V. E. FR.  
V. M. MODULANTE B. FR.  
V. M. MODULANTE E. SM.

MEMBRANA EPDM  
EPDM DIAPHRAGM  
MEMBRANE EPDM  
MEMBRANA EPDM

MEMBRANA PTFE  
PTFE DIAPHRAGM  
MEMBRANE PTFE  
MEMBRANA PTFE

**59W**

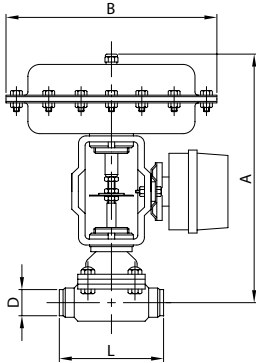

**59K**

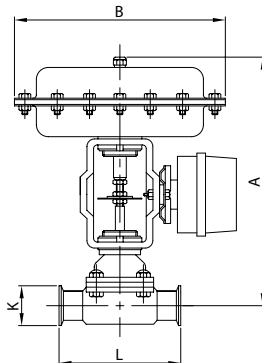

**57 E 08**

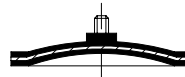

**57 T 08**

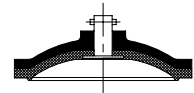

| DN        | A     | B     | D    | L     | gr     |
|-----------|-------|-------|------|-------|--------|
| 1/2" 12   | 305,5 | 290,0 | 12,7 | 89,0  | 11.840 |
| 3/4" 19   | 307,0 | 290,0 | 19,0 | 102,0 | 12.200 |
| 1" 25     | 311,0 | 290,0 | 25,4 | 114,0 | 12.680 |
| 1 1/2" 38 | 330,5 | 290,0 | 38,1 | 140,0 | 14.140 |
| 2" 51     | 345,5 | 290,0 | 50,8 | 159,0 | 16.040 |

| DN        | A     | B     | K    | L     | gr     |
|-----------|-------|-------|------|-------|--------|
| 1/2" 12   | 305,5 | 290,0 | 25,0 | 89,0  | 11.840 |
| 3/4" 19   | 307,0 | 290,0 | 25,0 | 102,0 | 12.200 |
| 1" 25     | 311,0 | 290,0 | 50,5 | 114,0 | 12.680 |
| 1 1/2" 38 | 330,5 | 290,0 | 50,5 | 140,0 | 14.140 |
| 2" 51     | 345,5 | 290,0 | 64,0 | 159,0 | 16.040 |

ELETTOVALVOLA NC.  
SOLENOID VALVE NC.  
ÉLECTROVANNE NF.  
ELECTROVÁLVULA NC.

CONNETTORE  
CONNECTOR  
CONNECTEUR  
CONECTOR

MICROINTERRUPTORE  
MICROSWITCH  
MINIRUPTEUR  
MICROINTERRUPTOR

CONTATTO DI PROSSIMITÀ  
PROXIMITY CONTACT  
CONTACT DE PROXIMITÉ  
MICROSENSOR

**015 NC**

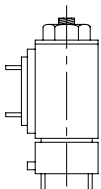

**030 S**

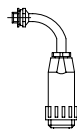

**014 1**

**014 2**

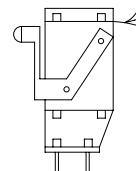

**013 A 013 A/N 013 A/N/EX**

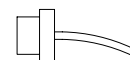

TUBO  
PIPE  
TUBE  
TUBO

TL

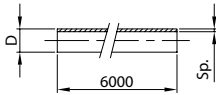

| DN  | D     | Sp.  | gr     |
|-----|-------|------|--------|
| 10  | 12,0  | 1    | 275    |
| 15  | 18,0  | 1    | 426    |
| 20  | 22,0  | 1    | 526    |
| 25  | 28,0  | 1,5  | 995    |
| 32  | 34,0  | 1,5  | 1.221  |
| 40  | 40,0  | 1,5  | 1.446  |
| 50  | 52,0  | 1,5  | 1.897  |
| 65  | 70,0  | 2    | 3.405  |
| 80  | 85,0  | 2    | 4.157  |
| 100 | 101,6 | 2,11 | 5.256  |
| 104 | 104,0 | 2    | 5.108  |
| 125 | 129,0 | 2    | 6.360  |
| 150 | 154,0 | 2    | 7.612  |
| 200 | 204,0 | 2    | 10.116 |

REGGIT. OTTAG. EL.  
OCTAG. P. HANGER PE.  
COLLIER OCTOG. BL.  
ABRAZAD. OCTAG. EL.

094 L

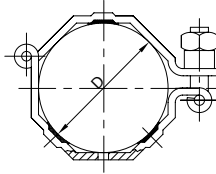

| DN  | D     | gr  |
|-----|-------|-----|
| 28  | 28,0  | 110 |
| 34  | 34,0  | 120 |
| 40  | 40,0  | 130 |
| 52  | 52,0  | 160 |
| 70  | 70,0  | 210 |
| 85  | 85,0  | 220 |
| 101 | 101,6 | 270 |
| 104 | 104,0 | 270 |

REGGIT. OTTAG. EF.  
OCTAG. P. HANGER ME.  
COLLIER OCTOG. BF.  
ABRAZAD. OCTAG. ER.

094 F

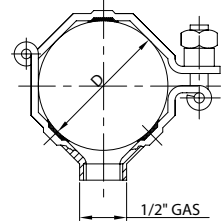

| DN  | D     | gr  |
|-----|-------|-----|
| 28  | 28,0  | 110 |
| 34  | 34,0  | 120 |
| 40  | 40,0  | 130 |
| 52  | 52,0  | 160 |
| 70  | 70,0  | 210 |
| 85  | 85,0  | 220 |
| 101 | 101,6 | 270 |
| 104 | 104,0 | 270 |

MORSETTO DOPPIO  
HEAVY DUTY CLAMP  
COLLIER CLAMP  
ABRAZADERA

K12 D

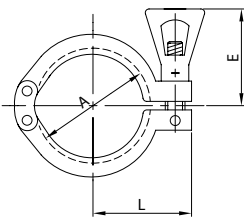

| DN  | A     | E    | L    | gr  |
|-----|-------|------|------|-----|
| 10  | 38,0  | 35,0 | 34,5 | 120 |
| 15  | 38,0  | 35,0 | 34,5 | 120 |
| 20  | 38,0  | 53,0 | 34,5 | 220 |
| 25  | 53,4  | 53,0 | 43,0 | 220 |
| 32  | 53,4  | 53,0 | 43,0 | 220 |
| 40  | 53,4  | 53,0 | 43,0 | 220 |
| 50  | 67,0  | 53,0 | 50,0 | 260 |
| 65  | 94,0  | 53,0 | 65,0 | 330 |
| 80  | 109,0 | 53,0 | 75,0 | 400 |
| 100 | 122,0 | 53,0 | 85,0 | 500 |

MORSETTO DOPPIO  
HEAVY DUTY CLAMP  
COLLIER CLAMP  
ABRAZADERA

K15 D

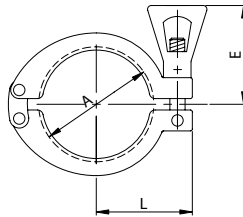

| DN  | A     | E    | L    | gr  |
|-----|-------|------|------|-----|
| 25  | 54,5  | 53,0 | 43,7 | 220 |
| 32  | 54,5  | 53,0 | 43,7 | 220 |
| 40  | 54,5  | 53,0 | 43,7 | 220 |
| 50  | 68,0  | 53,0 | 50,5 | 260 |
| 65  | 95,0  | 53,0 | 64,0 | 330 |
| 80  | 110,0 | 53,0 | 71,5 | 400 |
| 100 | 123,0 | 53,0 | 78,0 | 400 |

MORSETTO DOPPIO  
HEAVY DUTY CLAMP  
COLLIER CLAMP  
ABRAZADERA

K12 HPD

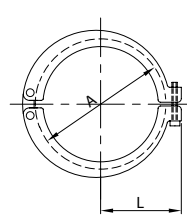

| DN  | A     | L     | gr    |
|-----|-------|-------|-------|
| 125 | 148,0 | 95,0  | 750   |
| 150 | 170,0 | 111,0 | 1.450 |
| 200 | 222,0 | 137,0 | 1.750 |

**SEMIRACCORDO SR.  
WG. FERRULE  
FERRULE SR.  
ENLACE SR.**

**K14 WD**

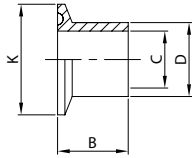

| DN  | B    | C     | D     | K     | gr    |
|-----|------|-------|-------|-------|-------|
| 10  | 9,5  | 9,5   | 12,0  | 34,0  | 19    |
| 15  | 15,5 | 15,5  | 18,0  | 34,0  | 20    |
| 20  | 19,5 | 19,5  | 22,0  | 34,0  | 30    |
| 25  | 28,6 | 25,0  | 28,0  | 50,5  | 70    |
| 32  | 28,6 | 31,0  | 34,0  | 50,5  | 65    |
| 40  | 28,6 | 37,0  | 40,0  | 50,5  | 60    |
| 50  | 28,6 | 49,0  | 52,0  | 64,0  | 95    |
| 65  | 28,6 | 66,0  | 70,0  | 91,0  | 150   |
| 80  | 28,6 | 81,0  | 85,0  | 106,0 | 195   |
| 100 | 28,6 | 100,0 | 104,0 | 119,0 | 235   |
| 125 | 28,6 | 124,0 | 129,0 | 144,4 | 805   |
| 150 | 28,6 | 149,0 | 154,0 | 166,8 | 1.010 |
| 200 | 28,6 | 199,0 | 204,0 | 218,0 | 1.410 |

**GUARNIZIONE  
GASKET  
JOINT  
JUNTA**

**K40 D**

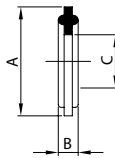

| DN  | A     | B   | C     |
|-----|-------|-----|-------|
| 10  | 34,0  | 5,5 | 9,5   |
| 15  | 34,0  | 5,5 | 15,5  |
| 20  | 34,0  | 5,5 | 19,5  |
| 25  | 50,5  | 5,5 | 25,0  |
| 32  | 50,5  | 5,5 | 31,0  |
| 40  | 50,5  | 5,5 | 37,0  |
| 50  | 64,0  | 5,5 | 49,0  |
| 65  | 91,0  | 5,5 | 66,0  |
| 80  | 106,0 | 5,5 | 81,0  |
| 100 | 119,0 | 5,5 | 100,0 |
| 104 | 119,0 | 5,5 | 97,6  |
| 125 | 144,4 | 5,5 | 124,0 |
| 150 | 166,8 | 5,5 | 149,0 |
| 200 | 218,0 | 5,5 | 199,0 |

**TAPPO  
SOLID END CAP  
BOUCHON  
TAPÓN**

**K16 D**

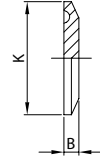

| DN  | B    | K     | gr    |
|-----|------|-------|-------|
| 10  | 6,4  | 34,0  | 15    |
| 15  | 6,4  | 34,0  | 15    |
| 20  | 6,4  | 34,0  | 70    |
| 25  | 6,4  | 50,5  | 70    |
| 32  | 6,4  | 50,5  | 70    |
| 40  | 6,4  | 50,5  | 70    |
| 50  | 6,4  | 64,0  | 140   |
| 65  | 6,4  | 91,0  | 410   |
| 80  | 6,4  | 106,0 | 480   |
| 100 | 6,4  | 119,0 | 570   |
| 125 | 13,0 | 144,4 | 1.925 |
| 150 | 13,0 | 166,8 | 2.600 |
| 200 | 13,0 | 218,0 | 3.900 |

**TEE EL.  
TEE PE.  
TE BL.  
TE EL.**

**200 D**

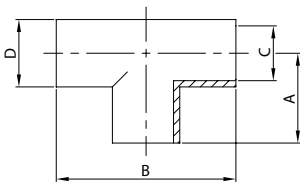

| DN  | A     | B     | C     | D     | gr    |
|-----|-------|-------|-------|-------|-------|
| 10  | 26,0  | 52,0  | 9,5   | 12,0  | 35    |
| 15  | 35,0  | 70,0  | 15,5  | 18,0  | 75    |
| 20  | 40,0  | 80,0  | 19,5  | 22,0  | 95    |
| 25  | 50,0  | 100,0 | 25,0  | 28,0  | 120   |
| 32  | 55,0  | 110,0 | 31,0  | 34,0  | 175   |
| 40  | 60,0  | 120,0 | 37,0  | 40,0  | 240   |
| 50  | 70,0  | 140,0 | 49,0  | 52,0  | 310   |
| 65  | 80,0  | 160,0 | 66,0  | 70,0  | 650   |
| 80  | 90,0  | 180,0 | 81,0  | 85,0  | 1.070 |
| 100 | 100,0 | 200,0 | 100,0 | 104,0 | 1.850 |
| 125 | 124,0 | 248,0 | 124,0 | 129,0 | 2.250 |
| 150 | 150,0 | 300,0 | 149,0 | 154,0 | 2.890 |
| 200 | 200,0 | 400,0 | 199,0 | 204,0 | 5.100 |

**CURVA 90° ES.  
BEND 90° WE.  
COUDE 90° BS.  
CURVA 90° ES.**

**310 D**

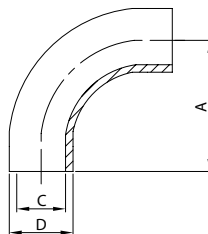

| DN  | A     | C     | D     | gr    |
|-----|-------|-------|-------|-------|
| 10  | 26,0  | 9,5   | 12,0  | 15    |
| 15  | 35,0  | 15,5  | 18,0  | 20    |
| 20  | 40,0  | 19,5  | 22,0  | 50    |
| 25  | 50,0  | 25,0  | 28,0  | 65    |
| 32  | 55,0  | 31,0  | 34,0  | 100   |
| 40  | 60,0  | 37,0  | 40,0  | 150   |
| 50  | 70,0  | 49,0  | 52,0  | 190   |
| 65  | 80,0  | 66,0  | 70,0  | 410   |
| 80  | 90,0  | 81,0  | 85,0  | 530   |
| 100 | 100,0 | 100,0 | 104,0 | 810   |
| 125 | 188,0 | 124,0 | 129,0 | 1.230 |
| 150 | 230,0 | 149,0 | 154,0 | 1.760 |
| 200 | 306,0 | 199,0 | 204,0 | 3.130 |

**TUBO  
PIPE  
TUBE  
TUBO**

**TL**

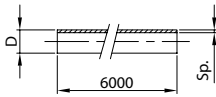

| DN     | D    | Sp.  | gr    |
|--------|------|------|-------|
| 1/4"   | 13,5 | 1,65 | 490   |
| 3/8"   | 17,2 | 1,65 | 640   |
| 1/2"   | 21,3 | 1,65 | 810   |
| 3/4"   | 26,9 | 1,65 | 1.040 |
| 1"     | 33,7 | 1,65 | 1.320 |
| 1 1/4" | 42,4 | 1,65 | 1.680 |
| 1 1/2" | 48,3 | 1,65 | 1.930 |
| 2"     | 60,3 | 2    | 2.920 |
| 2 1/2" | 76,1 | 2    | 3.710 |
| 3"     | 88,9 | 2    | 4.350 |

**REGGITUBO EL.  
PIPE HANGER PE.  
COLLIER BL.  
ABRAZADERA EL.**

**092 LD**

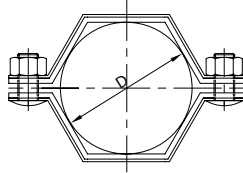

| DN     | D    | gr  |
|--------|------|-----|
| 1/4"   | 13,5 | 50  |
| 3/8"   | 17,2 | 70  |
| 1/2"   | 21,3 | 100 |
| 3/4"   | 26,9 | 120 |
| 1"     | 33,7 | 130 |
| 1 1/4" | 42,4 | 140 |
| 1 1/2" | 48,3 | 160 |
| 2"     | 60,3 | 180 |
| 2 1/2" | 76,1 | 220 |
| 3"     | 88,9 | 240 |

**REGGITUBO EL.  
PIPE HANGER PE.  
COLLIER BL.  
ABRAZADERA EL.**

**092 LG**

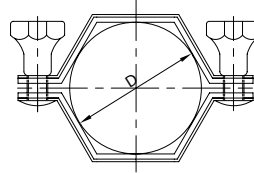

| DN     | D    | gr  |
|--------|------|-----|
| 1/4"   | 13,5 | 50  |
| 3/8"   | 17,2 | 70  |
| 1/2"   | 21,3 | 100 |
| 3/4"   | 26,9 | 120 |
| 1"     | 33,7 | 130 |
| 1 1/4" | 42,4 | 140 |
| 1 1/2" | 48,3 | 160 |
| 2"     | 60,3 | 180 |
| 2 1/2" | 76,1 | 220 |
| 3"     | 88,9 | 240 |

**REGG. TRONCHETTO  
STUB PIPE HANGER  
COLLIER FOURREAU  
ABR. ESPARRAGO**

**092 TD**

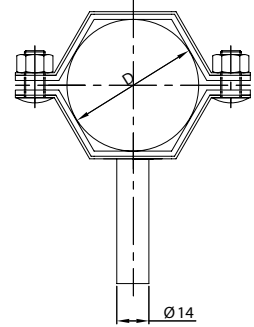

| DN     | D    | gr  |
|--------|------|-----|
| 1/4"   | 13,5 | 70  |
| 3/8"   | 17,2 | 90  |
| 1/2"   | 21,3 | 120 |
| 3/4"   | 26,9 | 140 |
| 1"     | 33,7 | 150 |
| 1 1/4" | 42,4 | 160 |
| 1 1/2" | 48,3 | 180 |
| 2"     | 60,3 | 200 |
| 2 1/2" | 76,1 | 240 |
| 3"     | 88,9 | 260 |

**REGG. TRONCHETTO  
STUB PIPE HANGER  
COLLIER FOURREAU  
ABR. ESPARRAGO**

**092 TG**

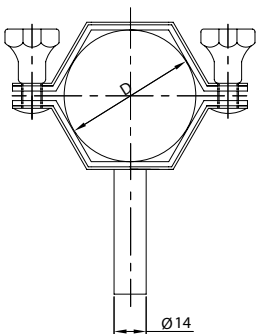

| DN     | D    | gr  |
|--------|------|-----|
| 1/4"   | 13,5 | 70  |
| 3/8"   | 17,2 | 90  |
| 1/2"   | 21,3 | 120 |
| 3/4"   | 26,9 | 140 |
| 1"     | 33,7 | 150 |
| 1 1/4" | 42,4 | 160 |
| 1 1/2" | 48,3 | 180 |
| 2"     | 60,3 | 220 |
| 2 1/2" | 76,1 | 240 |
| 3"     | 88,9 | 260 |

**MORSETTO DOPPIO  
HEAVY DUTY CLAMP  
COLLIER CLAMP  
ABRAZADERA**

**K12 I**

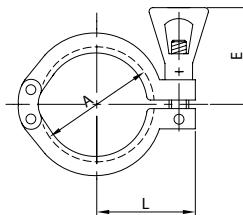

| DN     | A     | E    | L    | gr  |
|--------|-------|------|------|-----|
| 1/8"   | 38,0  | 53,0 | 34,5 | 120 |
| 1/4"   | 38,0  | 53,0 | 34,5 | 120 |
| 3/8"   | 38,0  | 53,0 | 34,5 | 120 |
| 1/2"   | 38,0  | 53,0 | 34,5 | 220 |
| 3/4"   | 53,4  | 53,0 | 43,0 | 220 |
| 1"     | 53,4  | 53,0 | 43,0 | 220 |
| 1 1/4" | 53,4  | 53,0 | 43,0 | 220 |
| 1 1/2" | 67,0  | 53,0 | 50,0 | 260 |
| 2"     | 80,4  | 53,0 | 56,5 | 330 |
| 2 1/2" | 94,0  | 53,0 | 65,0 | 400 |
| 3"     | 110,0 | 53,0 | 73,0 | 500 |

**MORSETTO DOPPIO  
HEAVY DUTY CLAMP  
COLLIER CLAMP  
ABRAZADERA**

**K15 I**

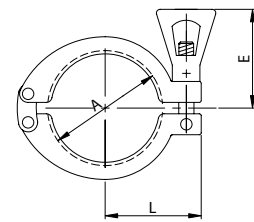

| DN     | A     | E    | L    | gr  |
|--------|-------|------|------|-----|
| 3/4"   | 53,4  | 53,0 | 43,7 | 220 |
| 1"     | 53,4  | 53,0 | 43,7 | 220 |
| 1 1/4" | 53,4  | 53,0 | 43,7 | 220 |
| 1 1/2" | 67,0  | 53,0 | 50,5 | 260 |
| 2"     | 80,4  | 53,0 | 57,2 | 330 |
| 2 1/2" | 94,0  | 53,0 | 64,0 | 400 |
| 3"     | 110,0 | 53,0 | 71,5 | 500 |

**MORSETTO DOPPIO  
HEAVY DUTY CLAMP  
COLLIER CLAMP  
ABRAZADERA**

**K12 HPI**

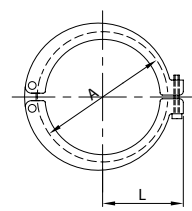

| DN | A     | L     | gr    |
|----|-------|-------|-------|
| 4" | 133,0 | 88,0  | 770   |
| 5" | 159,0 | 105,5 | 1.400 |
| 6" | 187,0 | 119,5 | 1.700 |
| 8" | 237,0 | 144,5 | 2.100 |



**SEMIRACCORDO SR.  
WG. FERRULE  
FERRULE SR.  
ENLACE SR.**

**K14 WI**

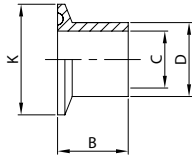

| DN     | B    | C     | D     | K     | gr  |
|--------|------|-------|-------|-------|-----|
| 1/8"   | 21,0 | 6,9   | 10,2  | 34,0  | 20  |
| 1/4"   | 21,0 | 10,2  | 13,5  | 34,0  | 20  |
| 3/8"   | 21,0 | 13,9  | 17,2  | 34,0  | 20  |
| 1/2"   | 21,0 | 18,0  | 21,3  | 34,0  | 40  |
| 3/4"   | 28,6 | 23,6  | 26,9  | 50,5  | 80  |
| 1"     | 28,6 | 30,4  | 33,7  | 50,5  | 75  |
| 1 1/4" | 28,6 | 39,1  | 42,4  | 50,5  | 60  |
| 1 1/2" | 28,6 | 45,0  | 48,3  | 64,0  | 95  |
| 2"     | 28,6 | 56,3  | 60,3  | 77,5  | 145 |
| 2 1/2" | 28,6 | 72,1  | 76,1  | 91,0  | 150 |
| 3"     | 28,6 | 84,9  | 88,9  | 106,0 | 210 |
| 4"     | 28,6 | 110,3 | 114,3 | 130,0 | 270 |
| 5"     | 28,6 | 135,7 | 139,7 | 155,0 | 470 |
| 6"     | 28,6 | 163,3 | 168,3 | 183,0 | 555 |
| 8"     | 28,6 | 214,1 | 219,1 | 233,5 | 700 |

**GUARNIZIONE  
GASKET  
JOINT  
JUNTA**

**K40 I**

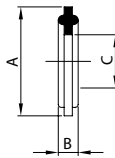

| DN     | A     | B   | C     |
|--------|-------|-----|-------|
| 1/8"   | 34,0  | 5,5 | 6,9   |
| 1/4"   | 34,0  | 5,5 | 10,2  |
| 3/8"   | 34,0  | 5,5 | 13,9  |
| 1/2"   | 34,0  | 5,5 | 18,0  |
| 3/4"   | 50,5  | 5,5 | 23,6  |
| 1"     | 50,5  | 5,5 | 30,4  |
| 1 1/4" | 50,5  | 5,5 | 39,1  |
| 1 1/2" | 64,0  | 5,5 | 45,0  |
| 2"     | 77,5  | 5,5 | 56,3  |
| 2 1/2" | 91,0  | 5,5 | 72,1  |
| 3"     | 106,0 | 5,5 | 84,9  |
| 4"     | 130,0 | 5,5 | 110,3 |
| 5"     | 155,0 | 5,5 | 135,7 |
| 6"     | 183,0 | 5,5 | 163,3 |
| 8"     | 233,5 | 5,5 | 214,1 |

**TAPPO  
SOLID END CAP  
BOUCHON  
TAPÓN**

**K16 I**

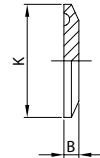

| DN     | B    | K     | gr    |
|--------|------|-------|-------|
| 1/4"   | 6,4  | 34,0  | 15    |
| 3/8"   | 6,4  | 34,0  | 15    |
| 1/2"   | 6,4  | 34,0  | 70    |
| 3/4"   | 6,4  | 50,5  | 70    |
| 1"     | 6,4  | 50,5  | 70    |
| 1 1/4" | 6,4  | 50,5  | 70    |
| 1 1/2" | 6,4  | 64,0  | 140   |
| 2"     | 6,4  | 77,5  | 260   |
| 2 1/2" | 6,4  | 91,0  | 350   |
| 3"     | 6,4  | 106,0 | 480   |
| 4"     | 6,4  | 130,0 | 750   |
| 5"     | 13,0 | 155,0 | 1.890 |
| 6"     | 13,0 | 183,0 | 2.600 |
| 8"     | 13,0 | 233,5 | 4.100 |

**TEE EL.  
TEE PE.  
TE BL.  
TE EL.**

**W7 I**

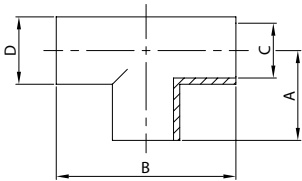

| DN     | A     | B     | C     | D     | gr    |
|--------|-------|-------|-------|-------|-------|
| 1/4"   | 25,5  | 51,0  | 10,2  | 13,7  | 30    |
| 3/8"   | 25,5  | 51,0  | 13,9  | 17,2  | 40    |
| 1/2"   | 25,5  | 51,0  | 18,0  | 21,3  | 50    |
| 3/4"   | 28,5  | 57,0  | 23,6  | 26,9  | 100   |
| 1"     | 38,0  | 76,0  | 30,4  | 33,7  | 150   |
| 1 1/4" | 47,5  | 95,0  | 39,1  | 42,4  | 235   |
| 1 1/2" | 57,0  | 114,0 | 45,0  | 48,3  | 350   |
| 2"     | 63,5  | 127,0 | 56,3  | 60,3  | 470   |
| 2 1/2" | 76,0  | 152,0 | 72,1  | 76,1  | 750   |
| 3"     | 85,5  | 171,0 | 84,9  | 88,9  | 930   |
| 4"     | 105,0 | 210,0 | 110,3 | 114,3 | 1.460 |
| 5"     | 124,0 | 248,0 | 135,7 | 139,7 | 2.070 |
| 6"     | 150,0 | 300,0 | 163,3 | 168,3 | 3.080 |

**CURVA 90° ES.  
BEND 90° WE.  
COUDE 90° BS.  
CURVA 90° ES.**

**W2C I**

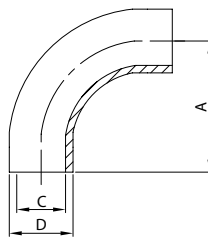

| DN     | A     | C     | D     | gr    |
|--------|-------|-------|-------|-------|
| 1/4"   | 20,2  | 10,2  | 13,7  | 20    |
| 3/8"   | 28,5  | 13,9  | 17,2  | 25    |
| 1/2"   | 31,8  | 18,0  | 21,3  | 30    |
| 3/4"   | 28,6  | 23,6  | 26,9  | 45    |
| 1"     | 38,1  | 30,4  | 33,7  | 100   |
| 1 1/4" | 47,6  | 39,1  | 42,4  | 150   |
| 1 1/2" | 57,2  | 45,0  | 48,3  | 200   |
| 2"     | 76,2  | 56,3  | 60,3  | 340   |
| 2 1/2" | 95,2  | 72,1  | 76,1  | 530   |
| 3"     | 114,3 | 84,9  | 88,9  | 820   |
| 4"     | 152,4 | 110,3 | 114,3 | 1.340 |
| 5"     | 190,5 | 135,7 | 139,7 | 2.020 |
| 6"     | 228,6 | 163,3 | 168,3 | 2.890 |

Foto:  
*LUCA VENTURA*  
Milano

Composizione:  
*COMPOSTUDIO*  
Cernusco sul Naviglio (MI)

Fotolito:  
*COMPOSTUDIO*  
Cernusco sul Naviglio (MI)

Stampa:  
*ARTI GRAFICHE M. & G. PIROVANO*  
Novegro di Segrate (MI)

---

**F.LLI TASSALINI OFFICINA MECCANICA S.P.A.**  
**Via G. Di Vittorio 19/21 - 20068 Peschiera Borromeo (MI) - Italy**  
**Tel. (+39) 02 55 38 311 - Fax (+39) 02 54 73 441**  
**[www.tassalini.com](http://www.tassalini.com)**  
**[info@tassalini.it](mailto:info@tassalini.it)**