



## Positive sinusoidal displacement pumps

### SN series

Positive displacement pumps with a sinusoidal rotor:

- Gentle handling of the product thanks to the shape of the rotor and the working without any product slip and death zone.
- High flexibility for a wide range of customer requirements, products and duties.
- Very high efficiency.
- Excellent suction capability.
- Constant performance even with products having range of viscosities..

Flow rates from 0 to 36 m<sup>3</sup>/h

Max. pressure 15 bar

Suction capability up to 0,8 bar



#### ADVANTAGES

- Excellent suction capability - continuously open inlet.
- Extremely gentle product transfer.
- No foaming of the pumped product.
- Compact design.
- Dry running is possible for a short period.
- Nearly all main wearing parts can be exchanged inline, without disconnecting the inlet and outlet pipes.

#### PRODUCTS

- Low and high viscosity liquids; Cremes, Lotions, Products for the fine chemical and pharmaceutical industry, nearly all thin and thick liquid food products with or without particles. Products with a low abrasive content.

#### TYPICAL PUMPABLE PRODUCTS

- **Food industry:** Juices, Fruit concentrates, Beverages, Syrups, Alcoholic beverages, Waters etc., Diced tomatoes, Cooked vegetables in pieces, Fruit salads, Soups and other food products, Delicatessen salads, Chocolate and Creams.

- **Dairy industry:** Processed cheese, Yoghurt, Whey, Ricotta Cheese, Cheese Curd of all kinds, Butter.

- **Fine Chemicals and Cosmetics:** Cosmetic products, Cremes, Gel, Shampoo, Toothpaste, Body lotions, Cleaning liquids, Paints and coatings.

# SN series

## CHARACTERISTIC

- Single or double mechanical seal with flush and lip seals (available soon).
- Pump in 316 stainless steel with internal front bush, liners and scrapergate made from polymers.
- O-rings in EPDM or FKM.

A wide choice of materials and motorization options to suit customers' application and product requirements.

All the materials are FDA certified.

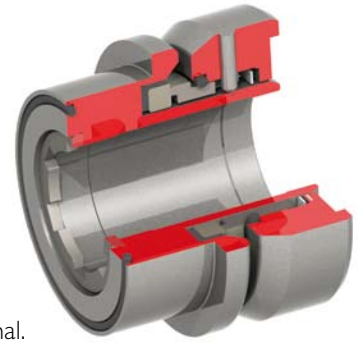

Single mechanical seal protected and bidirectional.

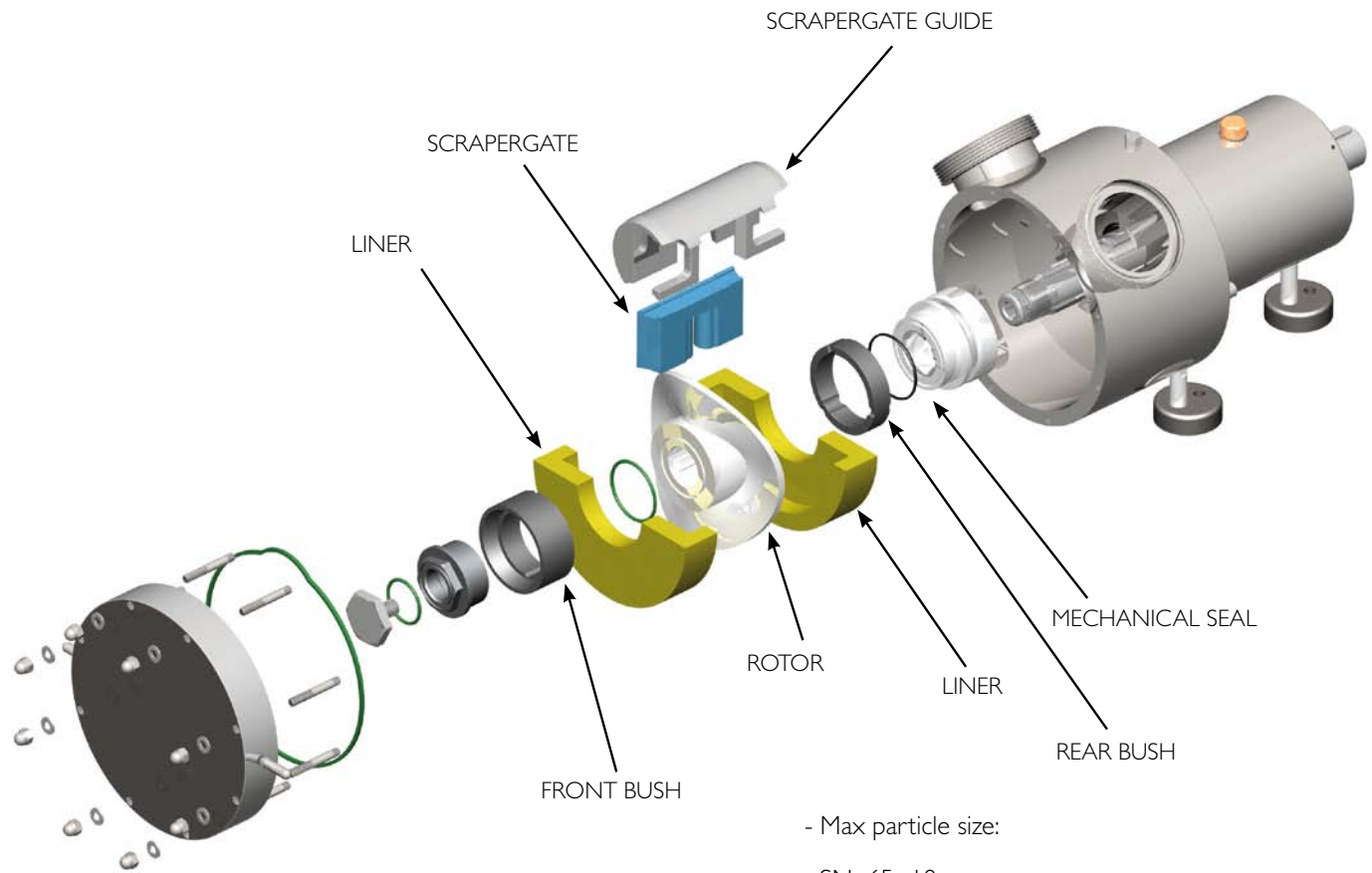

- Max particle size:

SN 65 : 18 mm  
 SN 80 : 25 mm  
 SN100 : 35 mm

SE100 : 35 mm  
 SE150 : 36/38 mm (coming next)

## Connections:

DIN - SMS - IDF - BS / RJT - DS - CLAMP and EN 1092-1 PN 16 flanges suitable for all international standards.

## Position of connections and rotation

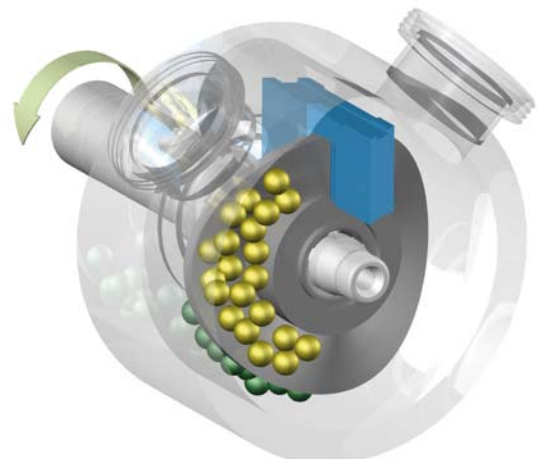
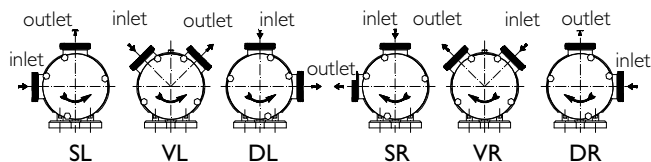

## PERFORMANCES

Curves show performance with clear water - specific gravity 1 (kg/dm<sup>3</sup>) - temperature 20° C

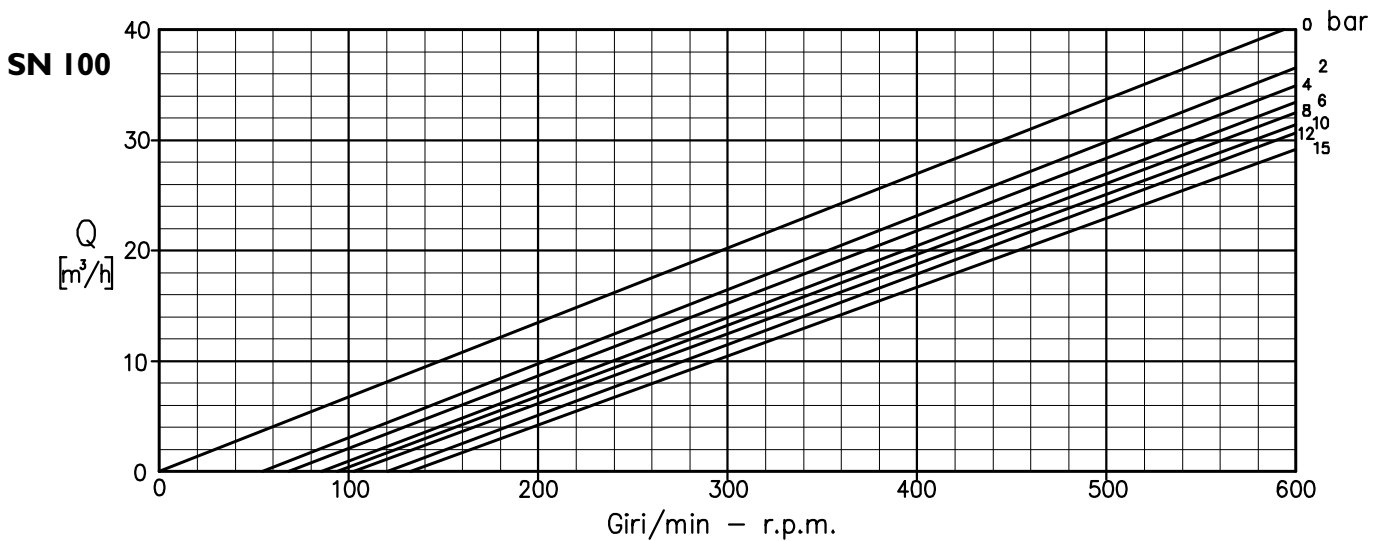
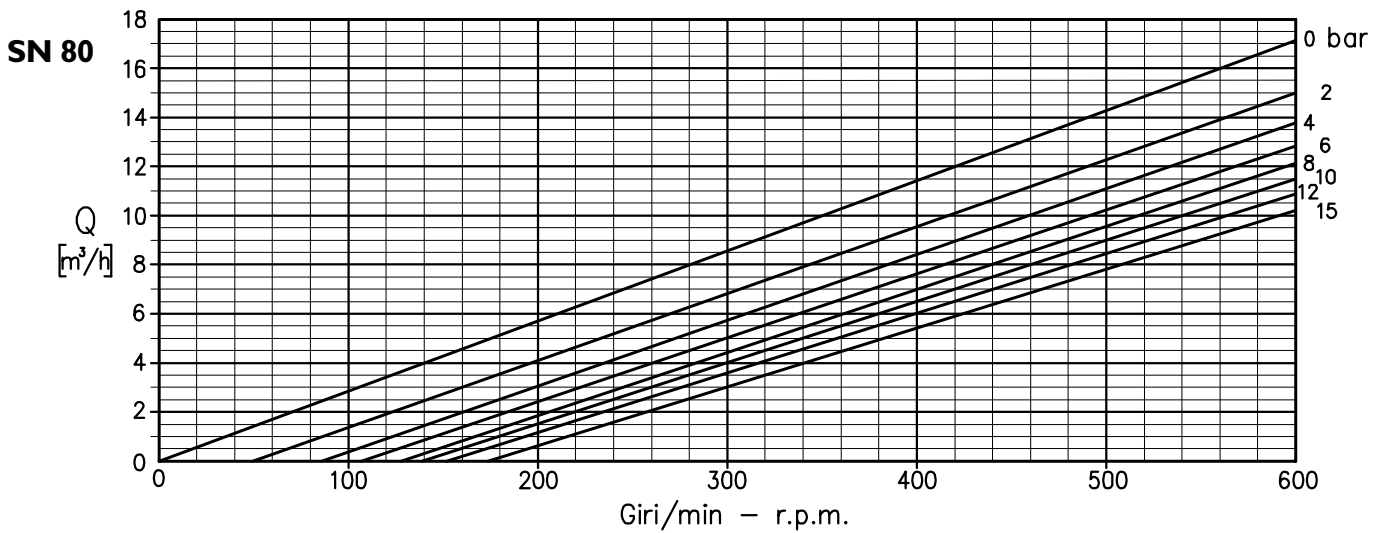
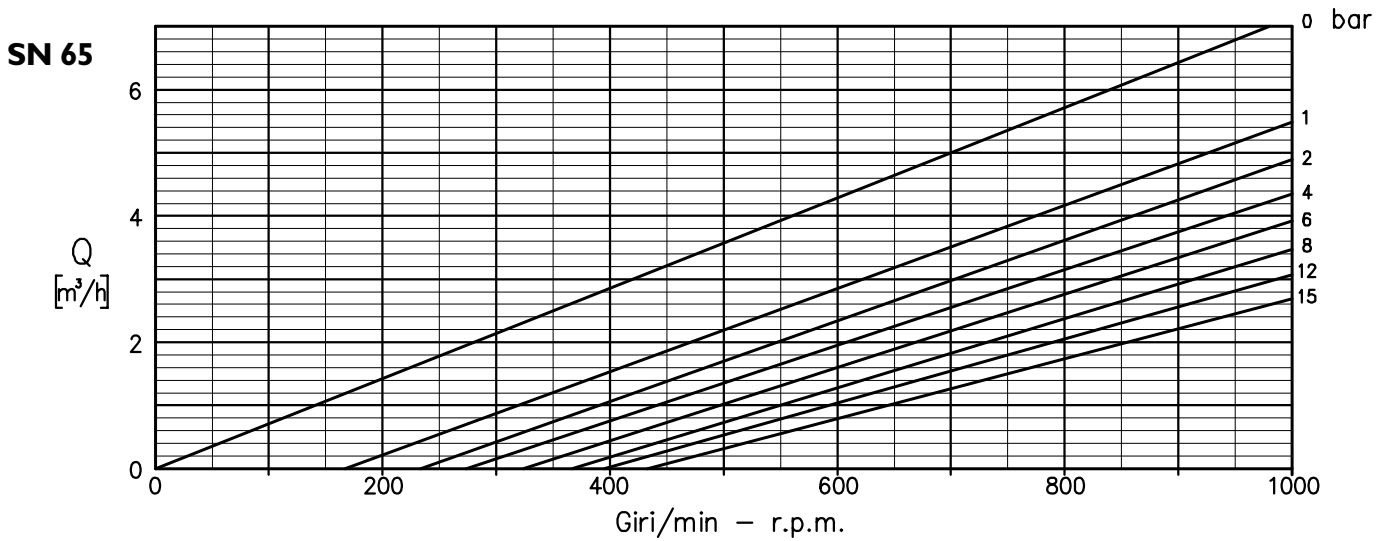

### SN Series (made from solid bar)

- Flow rates from 0 to 36 m<sup>3</sup>/h.
- Max. pressure 15 bar.
- Suction capability up to 8 meters with wetted pump.
- Temperatures between -10° and +90°C.
- Max. product viscosity up to 1.000.000 CP.

### SE Series (light, economical version - coming next)

- Flow rates from 0 to 100 m<sup>3</sup>/h.
- Max pressure 5 Bar.
- Suction capability up to 7 meters with wetted pump.
- Temperatures between -10° and +90°C.
- Max. product viscosity up to 500.000 CP.

# OVERALL DIMENSIONS - SN Series

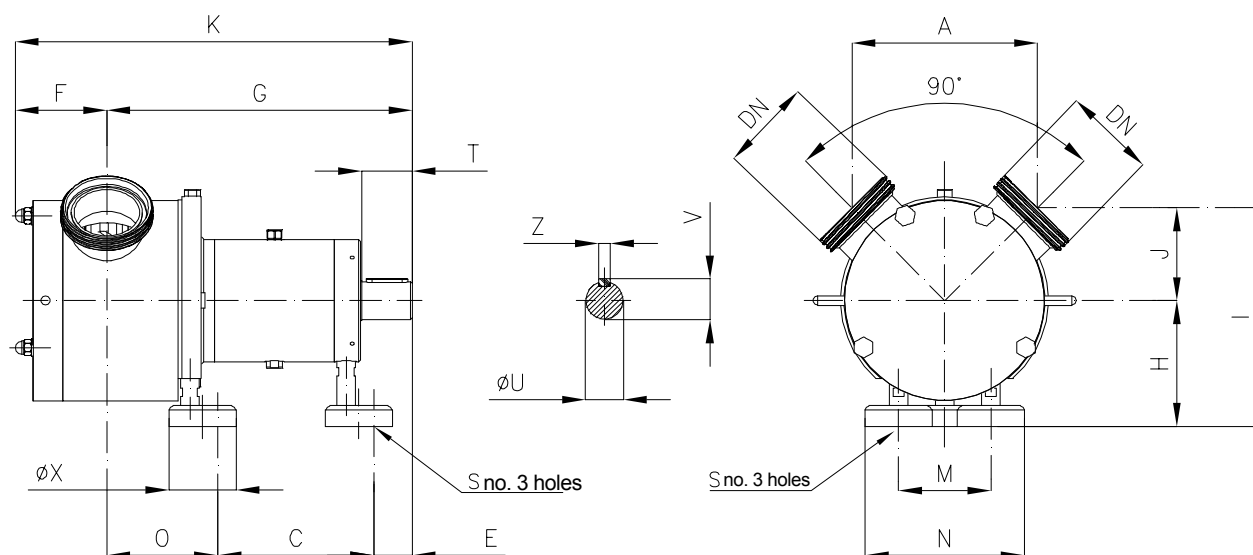

	Pump model		
	SN 65	SN 80	SN 100
A	150	221	263
C	117	186	247
E	37	45.5	69
F	81	109	132.5
G	251	363.5	463
H	95	150	195
K	332	472.5	596.5
J	68	110.5	139
I	163	260.5	334
M	56	110	160
N	106	190	240
O	97	132	147
S	12	16	16
T	50	60	80
U	28	45	50
V	31	48.5	53.5
X	50	80	80
Z	8	14	14
DN DIN 11851	65	80	100
DN SMS	2"1/2	3"	4"
DN RJT	2"1/2	3"	4"
DN Clamp	2"1/2	3"	4"
DN Flange PN16	65	80	100
Weight kg	21,5	75,5	138



**CSF Inox S.p.A.** Strada per Bibbiano, 7 - 42027 Montecchio E. (RE) - ITALY EU  
 Ph +39.0522.869911 ra. - Fx +39.0522.865454 / 866758 - csfitalia@csf.it - www.csf.it

**Export Department • Commercial Étranger • Comercial Extranjero**  
 Ph +39.0522.869922 - Fx +39.0522.869841 - csfexport@csf.it - www.csf.it

All the instructions, data and representations (in whatever way executed) listed in this publication are indicative and do not binding. CSF does not stand surety or undertake any obligation for the utilisation of this document and for the information contained. In particular, it does not guarantee against omissions or errors of the data and drawings here indicated.  
 Notice that the technical specifications, information and representations in this document are merely indicative and approximate. CSF INOX reserves the right at any moment and without notice to modify the data, drawings and information indicated in this document.