



Instruction manual

# DANA api MATIC



**swienty**

for better honey



**ENGLISH**





# Table of contents

Read before use.....	5
Introduction DANA api MATIC 1000 .....	6
Introduction DANA api MATIC 2000+ .....	7
Introduction DANA api MATIC 3000 .....	8
Startup.....	9
Overview keyboard .....	10
Display.....	10
Filling.....	11
Antidrip .....	11
Calibration.....	11
Motor's speed regulation.....	11
Pumping.....	11
Preparation of the machine.....	12
Height adjustment (DANA api MATIC 3000).....	13
Preparation for filling.....	14
Calibration.....	15
Cleaning.....	17
Cleaning with long storage.....	20
Configuration options.....	22
Mounting the anti-drip .....	23
Rubber diaphragm for filling nozzle.....	24
Rubber diaphragm with nozzle.....	24
Counterflow valve.....	24
Connecting equipment.....	25
Menu.....	26
Parameters .....	26
Log.....	28
Language.....	28
Reset.....	28
Function diagram .....	29
Factory setting values.....	33
Maintenance.....	31
Mounting of new sealing.....	31
Mounting of new shaft seal and ball bearing .....	31
Expansion drawings.....	33
DANA api MATIC 1000 .....	33
DANA api MATIC 2000+ og 3000 .....	34
FAQ - Typical errors.....	35
Air in the honey.....	36
O-ring in the pump housing.....	36
Conversion table .....	37
Fittings and accessories .....	38



## READ BEFORE USE

This manual is an original Swienty A/S manual for DANA api 1000, 2000+ and 3000. The goal of this manual is to ensure a correct use, handling and maintenance of the filling machine. The manual has to be kept in a place accessible for users and maintenance staff. It is the owner's responsibility to make sure that everyone that operates, services, maintains or repairs the filling machine has read the manual; or at least the part of the manual that is relevant for their work. Furthermore is everyone operating, servicing, maintaining or repairing the filling machine obliged to look for information in the manual themselves. **PICTURES OF BOTH DANA api MATIC 1000, 2000+ AND 3000 ARE USED IN THIS MANUAL, SINCE MOST PROCEDURES ARE THE SAME FOR ALL THREE MACHINES.**

Before the machine is used, it is necessary to make sure that the machine is placed on a stable surface, the wheels on the DANA api MATIC 3000 or the separately purchased stand are locked and the filling machine is placed in a well-lit area so the operation and cleaning can be conducted safely. The power cord (230 V) should be placed in a way that it does not pose a trip hazard during operation or cleaning (possibly hang up). **THE MACHINE MUST ALWAYS BE USED UNDER SUPERVISION.**

The product falls under directive 2002/96/EF on waste electrical and electronic equipment (WEEE).

The product may not be disposed of together with unsorted household waste. Use your local WEEE collection point to dispose of this product and make sure that all relevant regulations are complied with.

- Never use the filling machine with substances warmer than 50 degrees Celcius, since it can lead to heavy wear of the pump housing unless you have purchased additional equipment for warm substances.
- Never take off the pump housing without unplugging the machine, since it can lead to the exposure of moving parts.
- The pump may never run without a filling substance for a longer period of time (i.e. without honey or similar substance), because this may cause it to get too hot and thus damage the gears and/or shaft seals. .
- Clean the machine after use, see page 17.
- Never connect to power before all hoses and fittings are mounted to the pump.
- The machine should only be opened by a qualified technician.
- The machine should only be used for honey and similar substances. When in doubt contact Swienty.
- Never try to transport the machine without setting the height adjustment of the DANA api MATIC 3000 or the seperately purchased stand to its minimum position or without removing the funnel if you are using one. Otherwise the machine might turn over.

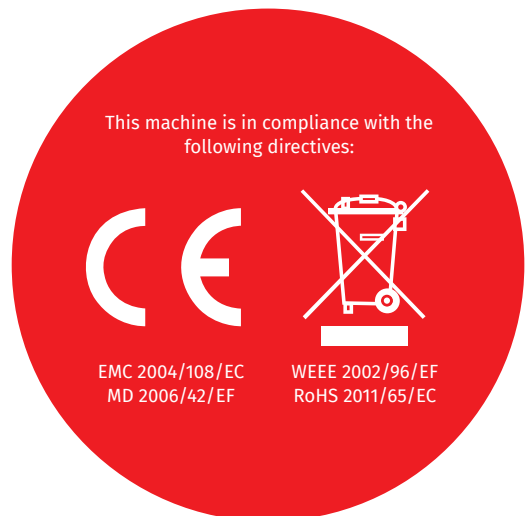

# INTRODUCTION DANA api MATIC 1000

The DANA api MATIC 1000 is a filling machine with a gear pump. A strong low voltage DC motor drives the gear pump with the help of a helical gear box. The motor is controlled by computer-based electronics, which also ensures a perfect anti-drip function. The filling machine has 20 filling programs with settings for weight, calibration factor and other filling parameters. The machine works precisely and is easy to program for different substances. As a pump, the machine works both ways and can be set to different speeds. All parts that come into contact with the substance are made from food grade plastic or stainless steel and are easy to take apart and to clean.

## TECHNICAL DATA

Machine type:	computer-controlled gear pump
Filling capacity:	10 g - ∞ g (honey)
Weight unit:	ml / g / oz
Precision:	+/- 2g
Pump capacity:	approx. 270 kg/hour
Programs:	20 + options to program
Power supply:	90-264VAC 50/60Hz
Power consumption:	230W
Sound level:	The sound pressure level of the pump is less than 70 dB(A)
Weight:	10.5 kg
Dimensions:	33 x 31 x 18.5 cm
Connections:	1½" BS hose connection on both sides of the pump



6  
7

# INTRODUCTION DANA api MATIC 2000+

The DANA api MATIC 1000 is a filling machine with a gear pump. A strong low voltage DC motor drives the gear pump with the help of a planetary gear. The motor is controlled by computer-based electronics, which also ensures a perfect anti-drip function. The filling machine has 20 filling programs with settings for weight, calibration factor and other filling parameters.

The machine works precisely and is easy to program for different substances. As a pump, the machine works both ways and can be set to different speeds.

All parts that come into contact with the substance are made from food grade plastic or stainless steel and are easy to take apart and to clean.

## TECHNICAL DATA

<b>Machine type:</b>	Computer-controlled gear pump
<b>Filling capacity:</b>	10 g - ∞ g (honey)
<b>Weight unit:</b>	ml / g / oz
<b>Precision:</b>	+/- 1g
<b>Pump capacity:</b>	approx. 610 kg/hour
<b>Programs:</b>	20 + options to program
<b>Power supply:</b>	90-305VAC 50/60Hz
<b>Power consumption:</b>	575W
<b>Sound level:</b>	The sound pressure level of the pump is less than 70 dB(A)
<b>Weight:</b>	17.5 kg
<b>Dimensions:</b>	51.5 x 31 x 18.5 cm
<b>Connections:</b>	2" BS hose connection on both sides of the pump



# INTRODUCTION DANA api MATIC 3000

DANA api MATIC 3000 is a filling machine with a gear pump. A powerful AC motor as well as a frequency converter drive the gear pump using a planetary gear. The motor is controlled by computer-based electronics, which also ensures a perfect anti-drip function. The filling machine has 20 filling programs with settings for weight, calibration factor and other filling parameters. The machine works precisely and is easy to program for different substances. As a pump, the machine works both ways and can be set to different speeds. All parts that come into contact with the substance are made from food grade plastic or stainless steel and are easy to take apart and to clean.

## TECHNICAL DATA

Machine type:	computer-controlled gear pump
Filling capacity:	10 g - ∞ g (honey)
Weight unit:	ml / g / oz
Precision:	+/- 1g
Pump capacity:	approx. 950 kg/hour
Programs:	20 + options to program
8 Power supply:	200-240VAC 50/60Hz
9 Power consumption:	1500W
Sound level:	The sound pressure level of the pump is less than 70 dB(A)
Weight:	40 kg
Dimensions:	62 x 42 x 18 cm
Connections:	1½" BS hose connection on both sides of the pump (1½" or 2")





## STARTUP

Begin by setting the machine to the language you would like to use.

Press [MENU], parameters are shown on the display, press [+] 2 times until LANGUAGE is blinking in the display, press [ENTER] to enter the menu.

Here you can set the language to English, German, French, Spanish, Italian or Danish by pressing [+]. All messages are now shown in the chosen language. Press [ENTER] to choose a language and [Stop/Back] to leave the menu.

Next, fill the pump head with the desired substance before you start using the machine and connect it to the supplied hose and fitting. For medium or high viscosity we recommend a 2" hose, which is available at Swienty. To guarantee a hassle-free filling the container should always be placed over or on the same height as the pump head. The machine is activated by connecting it to a power outlet. It is also possible to see a video guide by scanning the QR code (the video shows the DANA api MATIC 1000, but the procedure is the same for all three machines).



## OVERVIEW KEYBOARD



[CALIBRATE] Activate the calibration process of the set filling amount.



[DIRECTION] Set pump direction. Can only be changed when the motor is off.



[SPEED] Activate the motor's speed settings.



[ANTI DRIP] Prevents dripping after the filling stops.



[PROGRAM] Activate choice of program.



[PUMP/FILL] Change between filling and pumping.



[MENU] Open new settings and values.



[START] Start the filling or pumping process.



[+] Increase a value or show the next value.



[STOP/BACK] Stop the motor and interrupt the filling or pumping process. Also function as a 'back' button.



[-] Decrease a value or show the previous value.



[ENTER] Choose the shown value and save it.

10  
—  
11

## DISPLAY

When the filling machine is connected to the power outlet, it can for example show the following:

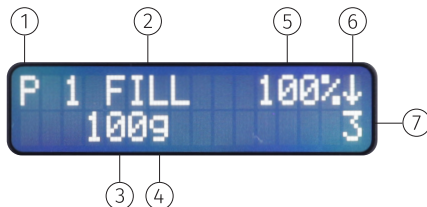

- 1: Program number that was used for the last filling.
- 2: Shows if the machine is set to pump or fill. Here it is set to fill.
- 3: Filling amount used for the last filling.
- 4: The unit that was used last (g, oz, ml).
- 5: The motor's speed in %.
- 6: Pump direction.
- 7: Amount of fillings, starts from 0 when the machine is turned off and on again. You can reset the amount of fillings for a single program by holding [STOP/BACK] down for 5 seconds.

## FILLING

When the machine is turned on, the display shows the settings that have been used for the last filling. Press the [START] button to begin filling. Furthermore you can start the machine with an external start impuls, e.g. the included foot pedal. In the beginning the filling amount is 0 and it then counts up to the set amount.

After that the motor stops immediately, takes a short break TIMEADRIP (see parameters) and shortly rotates backwards.

This prevents the machine from dripping after the filling (see anti drip function [ANTIDRIP]). If you want to increase/decrease the shown amount, press the [+]/[-] buttons. The filling amount blinks on the display.

When you have reached the desired amount, press the [ENTER] button. Now this amount is connected to the program until you set it again.

## ANTIDRIP

A problem with tough liquids like e.g. honey is that they can continue dripping after filling. To prevent this from happening, we have developed a special rubber nozzle that minimizes this. At the same time the motor rotates backwards for a short time to suck a small amount back in. This amount depends on the consistency of the substance.

Press [ANTIDRIP]. The number blinking on the display stands for the return pulses. With the [+]/[-] buttons the number can be changed (the higher the number, the more backflow). Save with [ENTER]. If the number is too low, then the machine drips, if it is too high, then the machine sucks in too much air. With the next filling the air will then loudly be pressed out again.

## CALIBRATION

To make sure that the amount shown on the display matched the filled amount, the machine needs to be calibrated.

Do a testrun and measure it on a calibrated scale. If the display shows e.g. 500g but the scale measures 520g, the value from the scale needs to be transferred to the machine.

With the [+] button you set the value to 520. The number blinks. Instead of saving with [ENTER], you need to press [CALIBRATE]. The number on the display jumps back to 500g. Now the machine is calibrated (in some cases this process needs to be repeated a few times).

## MOTOR'S SPEED REGULATION

In some cases it can be necessary to regulate the pump capacity and thus the motor's speed.

Press the [SPEED] button. The speed setting blinks. Using the [+]/[-] buttons you set the desired speed in percentage. Save by pressing [ENTER]. Can be set in 5% intervals.

The speed regulation can also be changed while the machine is filling or pumping. In connection with a turn table it can be necessary to decrease the speed to be able to follow along.

## PUMPING

When the machine should be used as a pump, press [PUMP/FILL]. To change the pump direction, press [DIRECTION]. The arrow on the display now points in the opposite direction.

Press [START] to start the pump. The pump amount starts at 0 and then counts up. To stop the pump press the [STOP/BACK] button. The pumped amount blinks on the display. If you want to continue pumping, press [START], then the machine begins to pump again and the pump amount counts further up.

To reset the pump amount, stop the machine and press [STOP/BACK] again.

## PREPARATION OF THE MACHINE



1 Clean the pump housing, see page 18 point 7-18.



2 Mount the pump housing to the machine. Remember that the clutch teeth need to be in the right position, otherwise it cannot be put on all the way. Make sure that the machine is placed on a stable ground before using it.



3 Optional: connect a foot pedal.

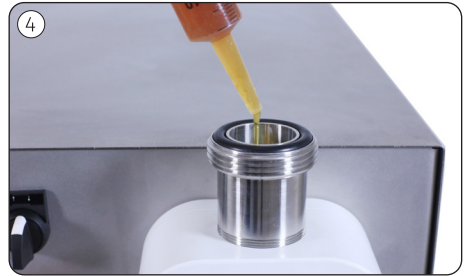

4 Place a jar/bowl under the pump housing. Dilute the pump housing with the desired substance that you would like to fill. Fill it up all the way to the edge of the fitting.



5 Mount the hose to the fitting. It is important to mount the hose clamp behind the bulge and to check for cracks in the hose after!

Tip: warm the hose up with warm water before pushing it over the pipe. This makes the mounting easier.



6 Connect to the power supply. The power cord (100-260V) must be placed in a way that it does not pose a tripping hazard and so that the machine can be cleaned safely (possibly hang it up). NOTE never connect to power before the hose fitting and anti-drip cut-off valve with nut are mounted.



Set the machine to pump by pressing [PUMP/FILL]. Pump for 1-2 sec. and then fill up the pump housing to the edge again.



Tip: for optimal operation we recommend that the tank is placed on the same level with or above the pump housing. Shown with a funnel here, which we recommend for small filling amounts.



Connect the hose to the tank and the machine.

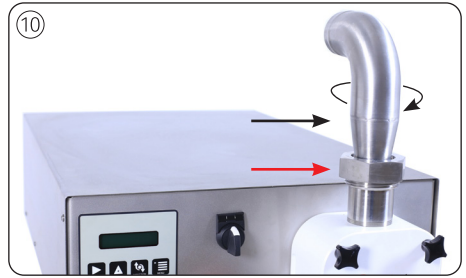

The fittings can be tightened without tools. Grasp the nut (red arrow) with your left hand and the fitting/hose with your right hand. Pull clockwise on the fitting and nut. This is how to tighten the fitting without using tools. Check the tank fittings as well!

## HEIGHT ADJUSTMENT (DANA api MATIC 3000)



Loosen the two screws in the legs (as you can see on the picture above). NOTE never stick your fingers into the space that opens up! You can injure your fingers.



The button in the red circle is used to adjust the height of the filling machine. When you have set the desired height, tighten the screws again as can be seen in picture 1.

## PREPARATION FOR FILLING



Set the machine to pump by pressing the [PUMP/FILL] button. The display must show PUMP. Remember to check if the pump direction is set correctly. Use the [DIRECTION] button to make a change.

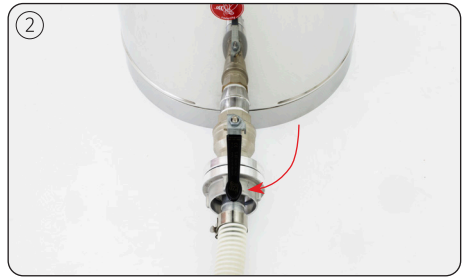

Open the valve of the container.



Set a bigger container under the pump housing.



Press [START]. Pump until the air is out of the system and then press [STOP].



Set the machine to fill with the [PUMP/FILL] button. The display shows FILL.



After the machine stops dripping, mount the cut-off mechanism. Can potentially be mounted first, but not when filling very tough substances.





Choose the program closest to the desired filling amount. Use the [PROGRAM] button.



Press the [+/-] button to find the desired program. Press [ENTER] to choose.



If necessary, press [+/-] and [-] to change the filling amount. Press [ENTER] to save and exit.



Before calibrating the machine, you need to start/carry out a single filling into a bucket. Press [START]. Let the machine carry out a filling until it stops by itself and carries out the anti-drip function.

## CALIBRATION



Put your jar on a scale and press [Z/T] (tara) to reset the scale.



Put the glass under the pump housing.



The machine must be set to FILL and the desired program. Press [START] or use the foot pedal.



Put the filled jar back on the scale.



Read the weight on the scale.



Press [+] and/or [-] until the same number appears on the display. Save by pressing [CALIBRATE].



Potentially repeat the calibration if the difference between weight and filling amount is big.



The machine is now calibrated and ready for filling.

# CLEANING



Start the machine to empty the container and hose.



Loosen the connection fitting so air can come into the pump housing, but not so much that the honey starts running out.  
**WARNING:** Always disconnect the machine from the power supply before taking the pump apart.



Completely take the connection fitting off.



In case of dripping put a bowl or something similar under the hose.



Unscrew the black nuts.



Grasp the notches at the end of the pump housing and gently pull the pump housing off the machine.



Go to the sink.



Unscrew the lowest fitting (nut).



Take off the cut-off mechanism.



Rinse the pump with water while turning the coupling. This loosens the honey so it is easier to open the pump housing.



Open the pump housing.



Take out the loose gear as well as the axis that are still in the pump housing. It can be necessary to rinse thoroughly with water to loosen the parts.



Take the big, black O-ring out.



Carefully press on the fixed axis so that a gap appears between the gear and the cover. Rinse here.

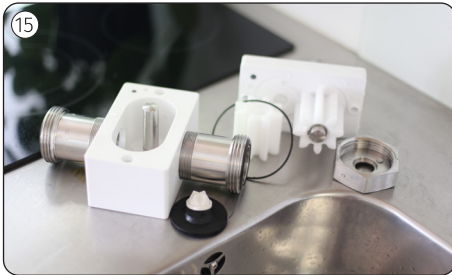

The pump housing can be cleaned in a dish washer (normal program) or by hand with detergent and warm water.

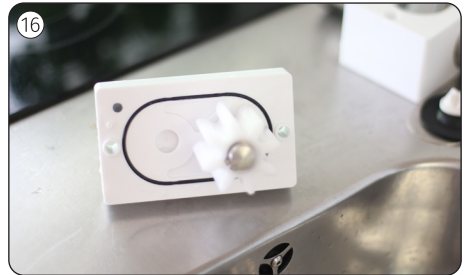

Tip: the O-ring can be lubricated with grease or the filling substance for extra sealing.



Put the pump housing together again.

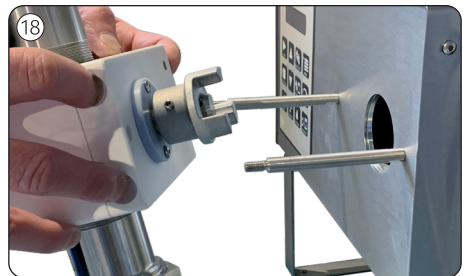

Remember to check that the clutch teeth fit, otherwise the pump housing cannot be put back on completely.



## CLEANING WITH LONG STORAGE (DANA api MATIC 2000+ AND 3000)



Follow the cleaning guide on page 17, from point 1-14.

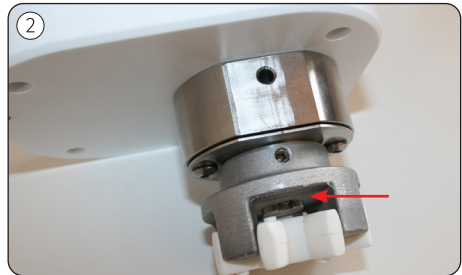

Loosen the Allen screw (red arrow), after which the claw cuppling can be pulled off the axis.

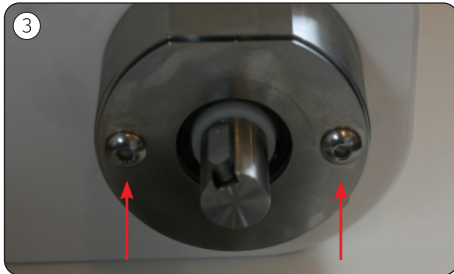

Loosen the two Allen screws and take off the plate.



Now you can pull out the axis, bearings and gasket out by carefully pulling on the axis (ATTENTION you must pull from the side you just took the plate off of).

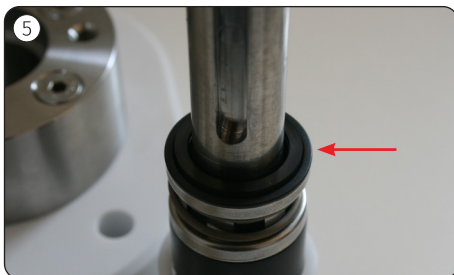

Rinse the black disc (red arrow) with water until all honey is gone.

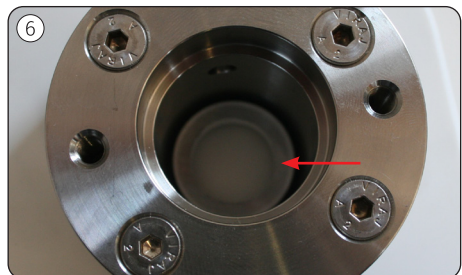

Also make sure to rinse all honey off the white ceramics disc (red arrow).





*When all honey is removed, you can begin to put everything together again.*

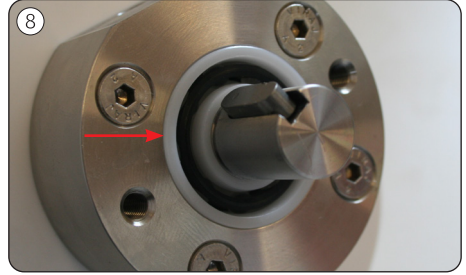

*Make sure that the bearing (re arrow) sits in the right position so that it aligns with the bearing housing. Now the plate can be screwed on, the claw coupling can be put on and the Allen screw can be tightened.*

# CONFIGURATION OPTIONS

## RECOMMENDED

- Optimal speed
- Highest precision
- Possibility of dripping

For mounting the anti dryp see page 23.

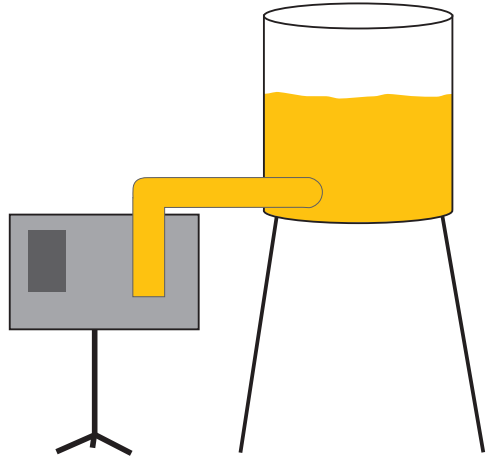

If you are using a fixed pipe installation, you need to install a piece of flexible hose between the container and the filling machine, to prevent vibrations and unnecessary pressure on the pump housing.

22  
—  
23

## ALSO POSSIBLE

- Less precise
- Counterflow valve can be useful here, item no. 110059

For mounting the anti dryp see page 23.

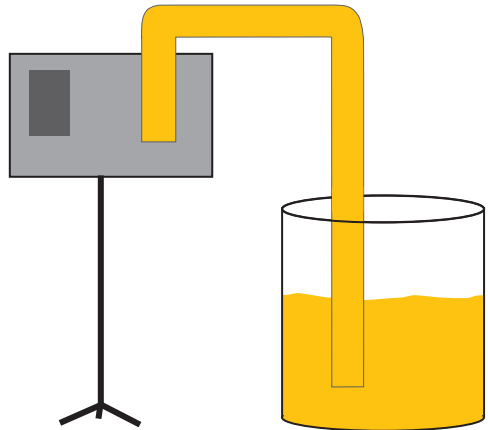

## MOUNTING THE ANTI-DRIP

### RUBBER DIAPHRAGM FOR FILLIG NOZZLE

The newly developed rubber diaphragm ensures a fast and drip free stop, also with very high viscosity.

It is **ABSOLUTELY NECESSARY**, that all parts are put in the depicted order:

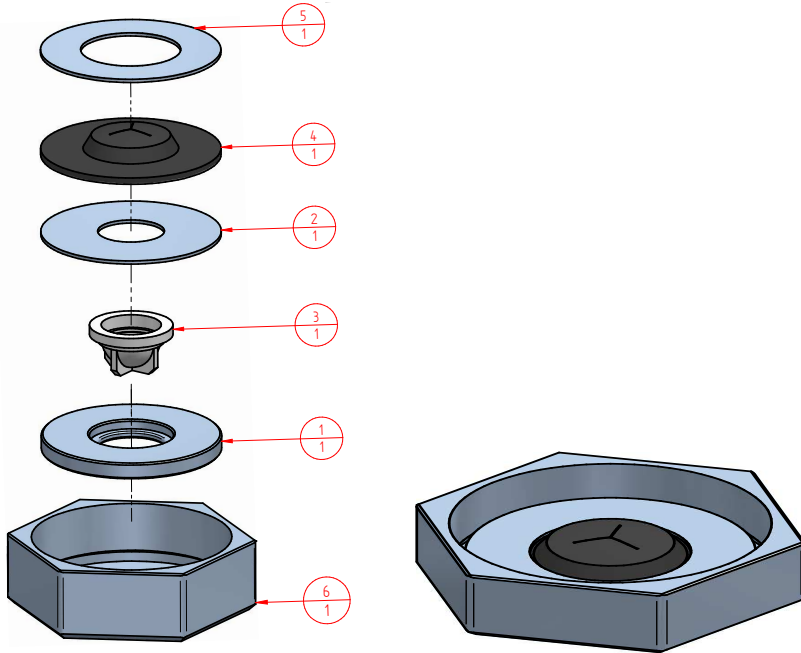

NO.	ITEM NO.	DOC. NO.	REV. NO.	TITLE	QTY.	MATERIAL
1	60750309F	dt-075-030	01	Front matix f/ ø20 Crossvalve	1	Stainless, 304 Skal ø60x7
2	110071A	dt-075-031	00	Back disk f/ ø20 Crossvalve	1	Stainless, 304 1mm B
3	110065D		00	ø20 Crossvalve	1	Con no. 110065D
4	110072	Gummilukker-3_slidser	00	Antidrip	1	Rubber NBR
5	110071	dt-004-082	00	Top and bottom washer	1	Stainless, 304 1 mm B
6	500110F		00	Nut BS 1,5	1	Con no. 500110F

With creamy honey you might be able to leave out part 1 and 3.  
 We also deliver nozzles for other purposes and substances.  
 Get advice from your dealer or contact Swienty.

## COUNTERFLOW VALVE (110059)

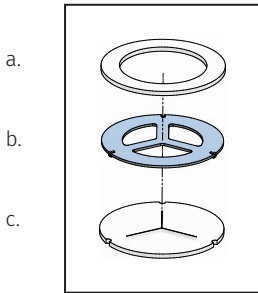

If your honey container stands lower than the filling machine and/or you take breaks during the filling process, honey can run back into the hose and this will lead to air in the honey when you start filling again. In that case, we recommend purchasing this counterflow valve. The counterflow valve is placed on the pump housing's inlet fitting.

- a) Seal
- b) Flow plate
- c) Counter plate

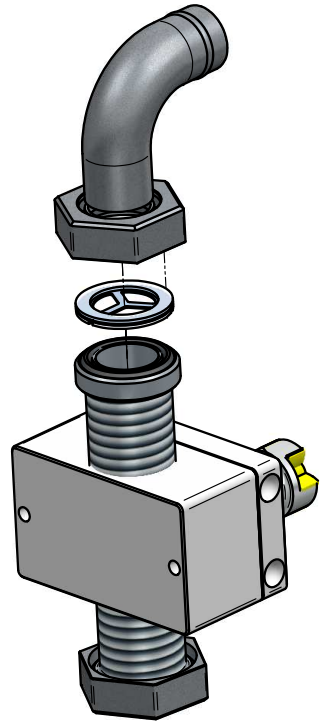

24  
—  
25

## RUBBER DIAPHRAGM WITH NOZZLE

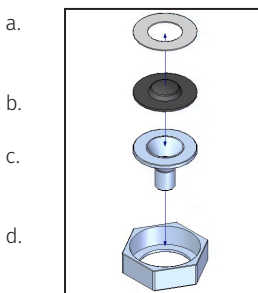

### **ADDITIONAL EQUIPMENT (NOT INCLUDED)**

This nozzle is used for filling into containers with a small opening.

It is absolutely necessary that all parts are put in the depicted order:

- a) Disc with hole
- b) Rubber diaphragm with three-sided notch
- c) Nozzle
- d) Nut

## CONNECTING EQUIPMENT

You will find this connector on the back of the filling machine. It is used to connect in- and outgoing signals to turntables and different mechanical sensors (foot pedal, micro switch). If you use a turntable with a sensor, connect the 5-pin connector on the turntable with this connector and the sensor with the 3-pin connector on the turntable.

1. Supply +24VDC (max. 4A)
2. Signal to stop filling or pumping
3. Supply 0VDC (GND)
4. Signal to start filling or pumping
5. Signal that filling is done

All signals are DC24V PNP (activ high) signals.

To start the filling machine connect pin 1 (24V DC) to pin 4 (START).

To stop the filling machine connect pin 1 (24V DC) to pin 2 (STOP).

The filling machine gives a DC24V signal for 0,1 seconds (can be changed under parameter) through pin 5 after each filling.

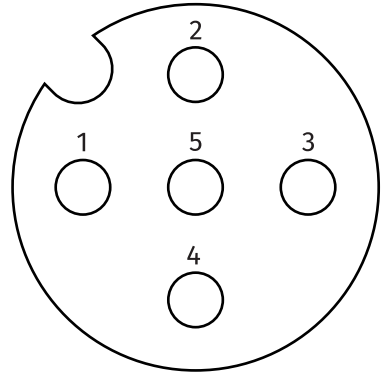

*5 poled M12 socket mounted on the back of the machine.*

# MENU

Under the [MENU] button there are a few parameters and settings which can be used for special circumstances. If you press that button, "PARAMETERS" blinks on the display. With the [+] / [-] buttons, you can jump between "LOG", "LANGUAGE", and "RESET" (see funktions diagram).

## PARAMETERS

Here you can change the parameters of the filling machine's 20 programs (these parameters are saved for each program number individually).



Press [ENTER], P(1-20) is shown. The last used program number blinks. Press [+] / [-] to change the program number, then press [ENTER] to see the parameters for the chosen program number.

**Special program speed** (use for containers where you would like an automatic change of speed during filling, typically for substances that foam a lot).

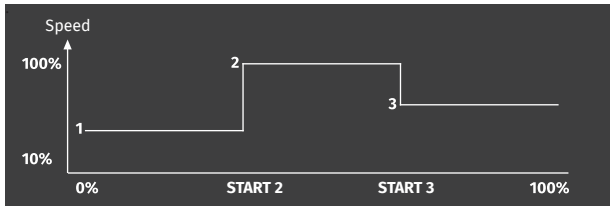

**Speed 1** - (can be set from 10% to 100% in steps of 5% (Factory setting is 100%)). This parameter determines the motor's speed during filling if parameters START 2 and START 3 are set to 100%, otherwise this parameter only determines the start speed until parameter START 2 or START 3 amount are reached. This parameter can also be set directly by using the [SPEED] button.

**Start 2** - Determines when the motor's speed should be changed to parameter SPEED 2. START 2 can be set from 1% to 100% of the entire filling amount in steps of 1% (Factory setting is 100%).

**Speed 2** - Determines the motor's speed after amount START 2 has been reached.

**Start 3** - Determines when the motor's speed should be changed to parameter SPEED 3. Only use for containers where you would like an automatic change of speed during filling. START 3 can be set from 1% to 100% of the total filling amount in steps of 1% (Factory setting is 100%).



**Speed 3** - Determines the motor's speed after amount START 3 has been reached.





**Timeadrip** - Determines the break before the motor rotates backwards with parameter ANTIDRIP amount of impulses. TIMEADRIP can be set from 0.10S to 9.90S in steps of 0.10S (Factory setting is 0.20S). This value should usually not be changed.



P 1 PARAMETERS  
TIME ADRIP 0.20S

**Antidrip** - Determines the amount of impulses the motor rotates backwards after TIMEADRIP is run out to prevent the machine from dripping after filling. ANTIDRIP can be set from 0 to 99 in steps of 1 (Factory setting is 6). You can also set this value directly with the [ANTI DRIP] button.



P 1 PARAMETERS  
ANTIDRIP 6

**Time ready** - Determines how much time should pass before the machine sends a (READY) signal to e.g. a turntable or another machine after the filling process ended. TIME READY can for example be used to prolong the dripping time for very tough honeys (typically in connection with a turntable). If you use the machine with a foot pedal, TIME READY can be set as a break time between to fillings so you have time to remove the filled jar and place an empty jar under the nozzle. TIME READY can be set from 0.00S to 9.90S in steps of 0.10S (Factory setting is 0.10S).



P 1 PARAMETERS  
TIME READY 0.10S

**Unit** - Determines which unit you would like to use. You can choose between g, OZ or ml.



P 1 PARAMETERS  
UNIT 9

**Calibration** - This is the calibration factor, which can be seen and changed here. It gets set when you calibrate the machine using the [CALIBRATE] button. We recommend not changing the calibration factor, but instead using the [CALIBRATE] button.



P 1 PARAMETERS  
CALIB FACT 1000

The values are only valid for the chosen program. Værdierne gælder kun for et givent program. To enter another program, press the [STOP/BACK] button. Press [STOP/BACK] to times to leave the menu function (see funktions diagram). Here you can set different values for the filling machine and its 20 programs. Press [ENTER], P(1-20) is shown. The last used program number blinks. To switch to another program, press [+]/[-].

## LOG

Press [MENU], parameters are shown on the display, press [+], LOG blinks on the display, press [ENTER] to get into the menu.

In the log you can see, how many kg, hours or number of containers the machine has filled. The values cannot be changed.

## LANGUAGE

Press [MENU], parameters are shown on the display, press [+] 2 times until LANGUAGE blinks in the display, press [ENTER] to enter the menu.

Here you can set the language to English, German, French, Spanish or Danish by pressing [+].

All messages are shown in the chosen language. Press [ENTER] to choose a language and [Stop/Back] to leave the menu.

## RESET

In this menu you can reset the machine to factory settings for the single programs.

See these values in the table on page 30.

### **Reset factory settings for the chosen program:**

Press [MENU], parameters are shown on the display, press [+] 3 times until RESET blinks on the display. Press [ENTER] to choose a program and [ENTER] again to reset the chosen program. The original values are now loaded. To leave the menu, press [STOP/BACK].

# FUNCTION DIAGRAM

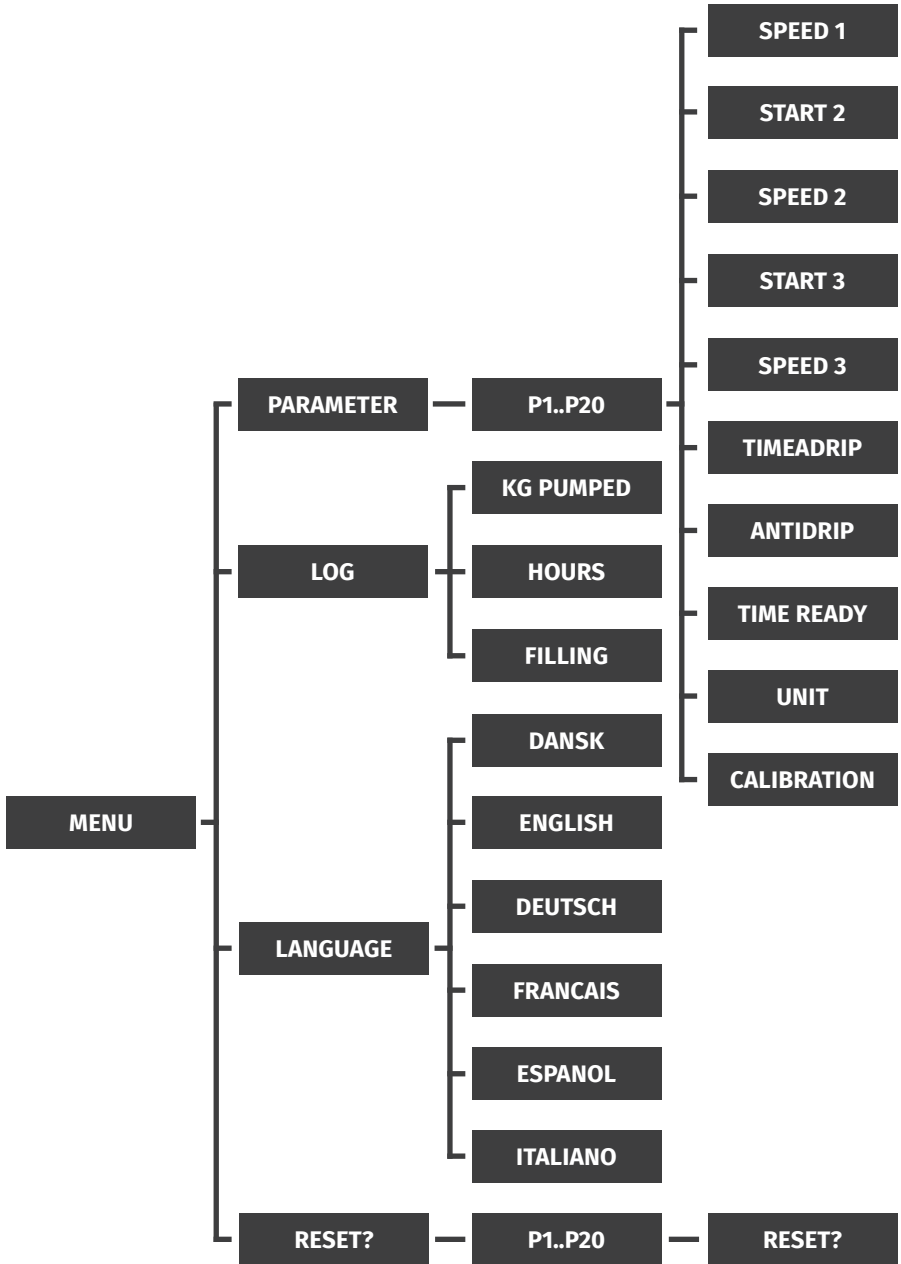

# FACTORY SETTING VALUES

Prog. no.	Amount	TP	TM	N	TD	Unit	Speed %	Calibration factor
P1	100	0.0	0.25	6	0.1	g	100	1000
P2	200	0.0	0.25	6	0.1	g	100	1000
P3	300	0.0	0.25	6	0.1	g	100	1000
P4	400	0.0	0.25	6	0.1	g	100	1000
P5	500	0.0	0.25	6	0.1	g	100	1000
P6	600	0.0	0.25	6	0.1	g	100	1000
P7	700	0.0	0.25	6	0.1	g	100	1000
P8	800	0.0	0.25	6	0.1	g	100	1000
P9	900	0.0	0.25	6	0.1	g	100	1000
P10	1000	0.0	0.25	6	0.1	g	100	1000
P11	1100	0.0	0.25	6	0.1	g	100	1000
P12	1200	0.0	0.25	6	0.1	g	100	1000
P13	1300	0.0	0.25	6	0.1	g	100	1000
P14	1400	0.0	0.25	6	0.1	g	100	1000
P15	1500	0.0	0.25	6	0.1	g	100	1000
P16	1600	0.0	0.25	6	0.1	g	100	1000
P17	1700	0.0	0.25	6	0.1	g	100	1000
P18	1800	0.0	0.25	6	0.1	g	100	1000
P19	1900	0.0	0.25	6	0.1	g	100	1000
P20	2000	0.0	0.25	6	0.1	g	100	1000

# MAINTENANCE

Other than cleaning the pump housing **NO** maintenance is necessary.



**ATTENTION:** The pump may never run without a filling substance for a longer period of time (i.e. without honey or similar substance), because this may cause it to get too hot and thus damage the gears and/or shaft seals.

## MOUNTING OF NEW SEALING - DANA API MATIC 1000

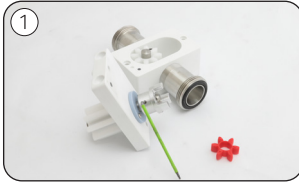

1  
Unscrew the coupling from the pump cover.

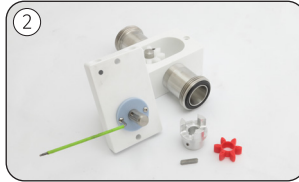

2  
Then screw off the plastic part.



3  
Use a small, flat screwdriver to remove the sealing from the backside of the pump cover.



4  
Put the new sealing in, now you can start to put the pump head together again.



5  
The sealing gets positioned by pressing the plastic part in with your fingers.



6  
The coupling needs to have approx. 5 mm distance from the plastic part to be able to rotate.

## MOUNTING OF NEW SHAFT SEAL AND BALL BEARING - DANA API MATIC 2000+ AND 3000



1  
Unscrew the coupling.



2  
Then unscrew the cover plate.

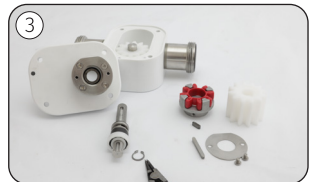

3  
Take the pump cover off, pull the drive shaft out and remove the circlip.

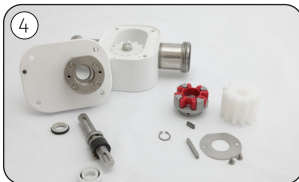

4  
Remove the seal inside the bearing housing and push/pull the gasket and shaft seal off the drive shaft.



5  
Now replace shaft seal and ball bearing with new ones and reassemble following instructions backwards.



6  
When mounting the coupling leave a millimeter to the screws so it can still rotate.



# EXPANSION DRAWINGS

## DANA api MATIC 1000

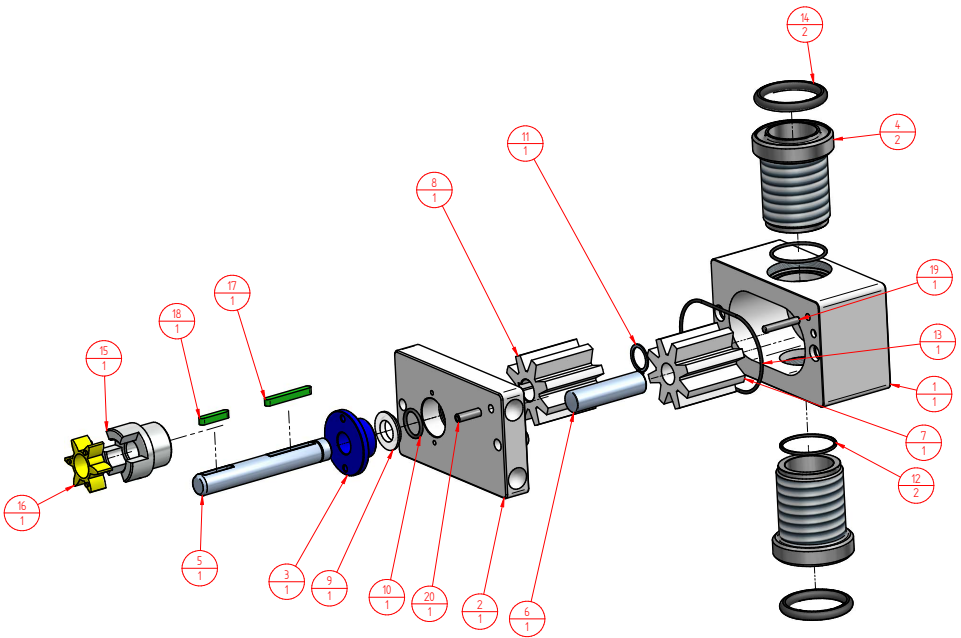

NO.	DOC. NO.	REV. NO.	TITLE	MATERIAL	Qty.	ITEM NO.
1	dt-054-010-1	09	Pump housing	TECAPET White FG	1	210037
2	dt-054-011-1	06	Pump cover	TECAPET White FG	1	210034
3	dt-004-015	00	Mupu holder	Riatal LF $\phi 50$	1	60040159UC
4	dt-004-010A	00	Fitting	Stainless steel, 304 Skal $\phi 60 \times 72$	2	6004010A9F
5	dt-054-007	00	Drive shaft	A304-slebet-h8 $\phi 16 \times 116$	1	6004008AF
6	dt-004-009	00	Pulley shaft	Stainless steel, 304 Blank $\phi 16 \text{ h}9 \times 65$	1	60040099F
7	Friløb	00	Gear $\phi 51,5 \times 52$ Modul 5 8-DC-41,5	Con no. 60543015F	1	60543015F
8	Trækhjul	00	Gear $\phi 51,5 \times 52$ Modul 5 8-DC-41,5	Con no. 60543015F	1	60543015F
9			Mupu seal 30312-0160-90-s	Con no. 508201	1	508201
10			O-ring $\phi 17,3 \times 2,4$	Con no. 508017	1	508017
11			Circlip $\phi 16$ A2	Con no. 701059D	1	701059D
12			O-ring $\phi 37 \times 2$	Con no. 508037	2	508037
13			O-ring $\phi 82 \times 2$	Con no. 508082	1	508082
14			O-ring BS 1.5	Con no. 500212	2	500212
15			Coupling pump housing	Nav no. 504505A	1	504505A
16			Clow clutch element $\phi 40$	Nav no. 504509	1	504509
17			Feather key acid-proof 5x5x40	Con no. 701019D	1	701019D
18			Feather key acid-proof 5x5x25	Con no. 701017	1	701017
19			Magnet 5x30 pump fuse	Nav no. 6004021	1	6004021
20	dt-054-035	00	Pin for magnet in pump housing	Steel	1	6054035

# DANA api MATIC 2000+ AND 3000

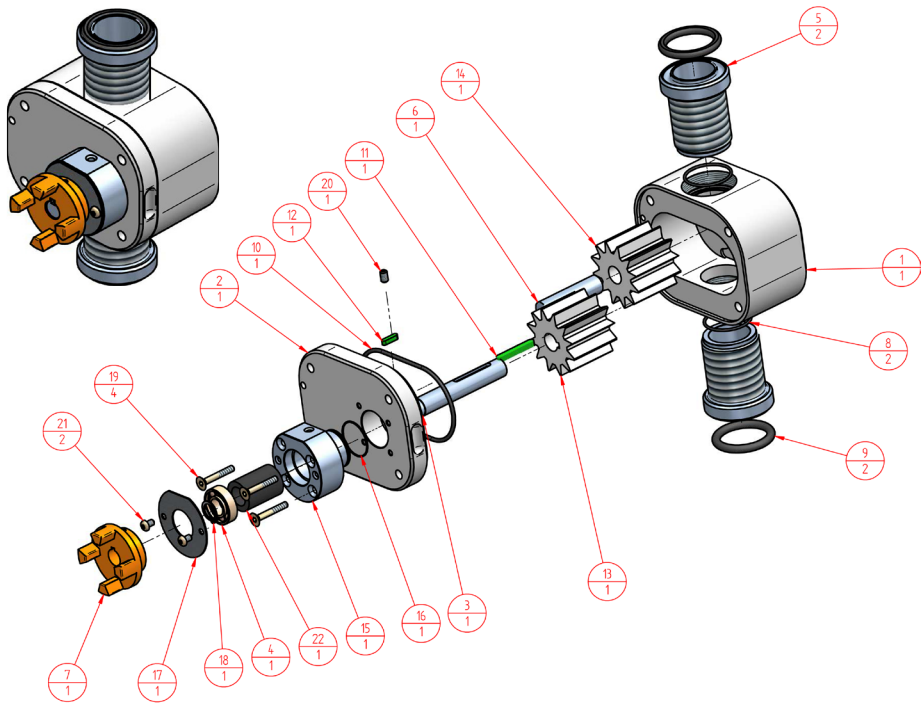

34  
35

NO.	DOC. NO.	REV. NO.	TITLE	MATERIAL	Qty.	ITEM NO.
1	dt-004-011-2	00	Pump housing	Rialan petp white 90x120x150	1	210038
2	dt-074-012-2	01	Pump cover	TECAPET white FG	1	210036
3	dt-074-016	02	Drive shaft f/ Crane seal	A304-polished-h8 ø16x116	1	6074016
4			6002-B180_10_GL_1 Glas bearing	Con no. 505170	1	505170
5	dt-004-010A	00	Fitting	Stainless steel, Skal ø60x72	2	6004010A9F
6	dt-004-009	00	Accelerator shaft	Stainless steel, Blank ø16 h9x65	1	60040099F
7	dt-074-017	02	Clutch ø15	Con no. 504500	1	6074017
8			O-ring ø37x2	Con no. 508037	2	508037
9			O-ring BS 1.5	Con no. 500212	2	500212
10			O-ring ø96x3	Con no. 508096	1	508096
11			Fitting spring acid-proof 5x5x40	Con no. 502705	1	701019D
12			Fitting spring acid-proof 5x5x16	Nav no. 701013	1	701013
13	dt-004-008	00	Module 4 ø59,2x47 12T DC 51,2 Træk	Pom white	1	60040081F
14	dt-004-008	00	Module 4 ø59,2x47 12T DC 51,2 Medløb	Pom white	1	60040081F
15	dt-074-024	01	Bearing housing f/ Crane seal	Stainless steel, 304 Skal ø65x46	1	60740249M0
16			O-ring ø30x1	Con no. 508030	1	508030
17	dt-074-028	03	Cover plate	Stainless steel, 304 1mm B	1	6074028F
18			Lock ring ø 15	Nav no. 701059C	1	701059C
19			M5x35 submerged Allen A2	Stainless steel, 304	4	700329
20			M6x10 Pinol A2	Stainless steel, 304	1	700433
21		00	M5x10 Buttonhead A2	Stainless steel, 304	2	700223
22			Shaft seal ø16	Con no. 508301	1	508301



# FAQ - TYPICAL ERRORS

## ERROR:

MACHINE DOESN'T START

WEIGHT DOESN'T MATCH WITH WHAT THE MACHINE DISPLAYS

AIR IN THE HONEY

THE MACHINE "SPLASHES"

MACHINE DOESN'T PUMP EVEN THOUGH IT STARTS

DISPLAY DOES NOT COUNT UP AFTER START

DISPLAY SHOWS "ENGINE OVERLOADED"

DISPLAY SHOWS "ERROR PUMP"

HONEY DRIPS EVEN THOUGH ANTIDRIP IS ACTIVATED

SUBSTANCE FOAMS TOO MUCH

## CAUSE/SOLUTION:

1. Is it connected to the power supply?
2. Is there light in the display?  
If not, please contact Swienty.

1. Was the machine calibrated correctly? See page 15.
2. Repeat the calibration.
3. Is there air in the honey? See below.
4. Is the anti drip mounted the correct way? See page 23.

1. Is the product inflow optimal? See page 36.
2. Check if the hose is leakproof.
3. Check if the pump housing is tightened properly.
4. Check if the O-ring is mounted correctly in its track in the pump housing.
5. Check if the O-ring in the inlet and outlet fitting are intact.
6. Check if the inlet fitting is tightened (see page 13, point 10).
7. Lower the antidrip value (see page 11, antidrip function).
8. If there is still air in the honey after following all these steps, please contact Swienty.

See AIR IN THE HONEY.

1. Have you filled the pump housing with your filling substance?
2. Check if the pump direction is set correctly (with the arrow's direction).

1. Reset the machine. See page 28.  
The machine is set to its factory settings, as it was set when you bought it. This means you need to set all values you have changed again.

1. The filling substance is too tough and the speed set too high. Let the machine cool down and lower the speed. If this doesn't help, check for mechanical errors in the pump housing. If this doesn't solve the problem, please contact Swienty.

1. Pump housing isn't mounted correctly, see page 36 (Swienty logo may not be upside down).
2. Check if nuts are tightened.

1. Set a waiting time between fillings. Often used in connection with a turntable. Set TIME READY to e.g. 1 sec. (see parameter setting TIME READY page 27).
2. Wait a second before taking the jar off the table.

See speed program page 26.

## AIR IN THE HONEY



It is important that the hose is pushed over the bulge (red arrow) and that the hose clamp is also placed on the other side of the bulge.

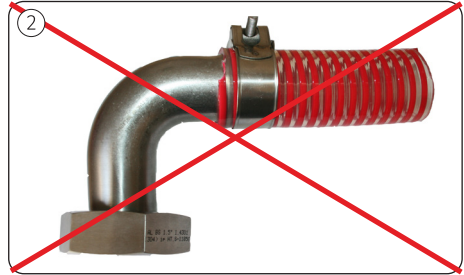

Here you can see how the hose should not be mounted. The hose clamp is mounted on the wrong side of the bulge.



Here you can see how the hose clamp should be placed behind the bulge.

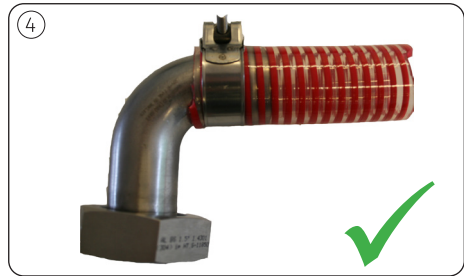

The hose is pushed over the fitting up to the bending. Remember to put the hose clamp on before! It is tightened directly behind the bulge. TIP: Put the hose in warm water for half a minute. Check if the hose has been mounted correctly.

## O-RING IN THE PUMP HOUSING



Make sure that the o-ring is intact and positioned correctly.  
**TIP:** potentially grease the o-ring with honey so it sits tightly before you close the pump housing.



Make sure the handmountable nuts are tightened and tightened evenly so the pump housing is not mounted skewed. The DANA api MATIC 1000 pump housing only has two nuts, but the procedure is the same.

## CONVERSION TABLE

1 ml honey = 1.44 g honey
---------------------------

1 ml honey = 0.051 oz honey
-----------------------------

1 g honey = 0.7 ml honey
--------------------------

1 g honey = 0.035 oz honey
----------------------------

1 oz honey = 19.73 ml honey
-----------------------------

1 oz honey = 28.35 g honey
----------------------------

**IF YOU FIND MISTAKES OR HAVE SUGGESTIONS FOR IMPROVEMENT, WE'D BE HAPPY TO HEAR FROM YOU:**

[www.swienty.com](http://www.swienty.com)

[shop@swienty.com](mailto:shop@swienty.com)

Tlf: +45 74 48 69 69

# FITTINGS AND ACCESSORIES

## INCLUDED FITTINGS



Foot pedal  
110075



Dosing syringe  
0-60 ml  
115815

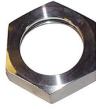

Nut BS 1 1/2  
500110F



Counterflow  
valve  
110059



Cut-off cross  
Ø20 complete  
110065C



Spare parts set



**DaM 1000**  
Legs 2 pcs.  
110046



**DaM 1000**  
Hose 1 1/2"/38mm  
110165



**DaM 1000**  
Fitting 1 1/2" bent  
110110A



**DaM 1000**  
Hose clamp 1 1/2"  
110175

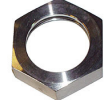

**DaM 1000**  
Nut for BS 1 1/2  
fitting  
500110F



**DaM 2000+**  
Legs 2 pcs.  
110056



**DaM 2000+ & 3000**  
Hose 2"/50mm  
110172



**DaM 2000+ & 3000**  
1 1/2-2" fitting bent  
110130



**DaM 2000+ & 3000**  
Hose clamp 2"  
110176

38  
—  
39

## SPARE PARTS SET

DANA api MATIC 1000 (110074B)

DANA api MATIC 2000+ and 3000 (110074A)



Cut-off valve Ø20  
110065D



Diaphragm  
110072



O-ring BS 1 1/2"  
500212



Handmountable nut  
for pump housing  
502740



O-ring 37x2  
NBR 70  
508037



**DaM 1000**  
O-ring 82x2 NBR 70  
for pump housing  
508082

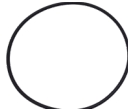

**DaM 2000+ & 3000**  
O-ring 96x3 NBR 70  
for pump housing  
508096

## EXTRA ACCESSORIES



Nozzle  
ø9mm  
110062



Nozzle  
ø15mm  
110063



Nozzle  
ø8x30mm  
110063a



Nozzle  
ø5x15mm  
110064



Nozzle  
ø3x40mm  
110068



1 1/2" fitting bent  
110110



1 1/2-2" fitting bent  
110130



1 1/2" fitting  
straight  
110100



1 1/2-2" fitting  
straight  
110120



Mupuseal  
with o-ring  
110073



Ball bearing  
505170



Shaft seal  
508301



Floor stand  
height-adjustable  
110055



Floor stand  
electrically adjustable  
110054



Tablestand  
110044



Glas handle  
for tablestand  
6054240F



Holder and switch  
110045



Hopper 10l  
110640\*



Hopper 20l  
110645\*



Quickcoupling  
1 1/2" male alu.  
110148



Quickcoupling 2"  
Nippel male alu.  
110144



Quickcoupling  
1 1/2" hose alu.  
110147



Quickcoupling  
2" hose alu.  
110143



Quickcoupling  
1 1/2" female alu.  
110149



Quickcoupling  
2" female alu.  
110145



Ball valve 1 1/2"  
110220



Ball valve 2"  
110210



Hex nipple 1 1/2"  
110221



Hex nipple 2"  
110211



Hose 1 1/2" FDA 90°  
110160



Hose 2" FDA 90°  
110170



Hose fitting  
DN40 -> 38mm  
110232



Hose fitting  
DN50 -> 38mm  
110232A



Butterfly  
valve 1 1/2"  
110241



Butterfly  
valve 2"  
110240

\*Hopper for DANA api MATIC 1000 required a tablestand (110044) to not tip over.









**Swienty A/S**

Hørtoftvej 16  
6400 Sønderborg  
Danmark

Tlf.: +45 74 48 69 69  
shop@swienty.com

**WWW.SWIENTY.COM**